

YASKAWA - RC5

Power Regenerative Unit

Instruction Manual

Type: CIMR-R5U

Models: 200 V Class, Three-Phase Input: 3.7 to 37 kW
400 V Class, Three-Phase Input: 3.7 to 75 kW

To properly use the product, read this manual thoroughly and retain for easy reference, inspection, and maintenance. Ensure the end user receives this manual.

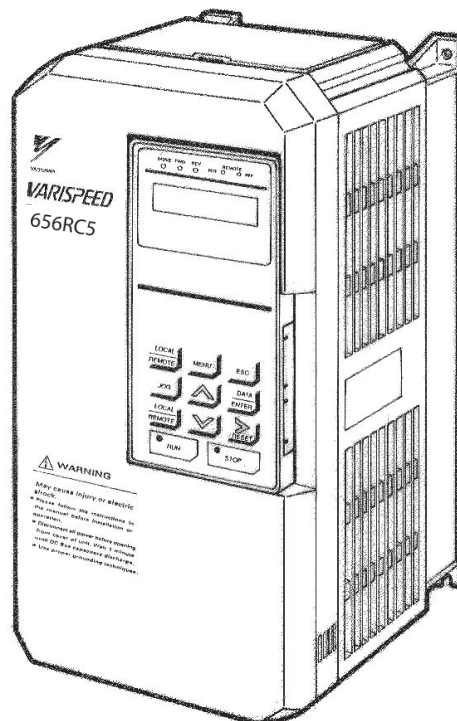

This Page Intentionally Blank

Copyright 2008 YASKAWA ELECTRIC CORPORATION. All rights reserved.

All rights reserved. No part of this publication may be reproduced, stored in a retrieval system, or transmitted, in any form or by any means, mechanical, electronic, photocopying, recording, or otherwise, without the prior written permission of Yaskawa. No patent liability is assumed with respect to the use of the information contained herein. Moreover, because Yaskawa is constantly striving to improve its high-quality products, the information contained in this manual is subject to change without notice. Every precaution has been taken in the preparation of this manual. Yaskawa assumes no responsibility for errors or omissions. Neither is any liability assumed for damages resulting from the use of the information contained in this publication

Table of Contents

I.	PREFACE.....	3
	i.1 Conditions of Acceptability	4
	NEC, CEC and UL Compliance	4
	CSA Standards Compliance	4
	i.2 Safety Information	5
	Supplemental Safety Information	5
	i.3 Notes for Safe Operation.....	6
	Receiving	6
	Installation	6
	Wiring	6
	Operation	7
	Maintenance and Inspection	7
	Warning Label	8
1.	RECEIVING	11
	1.1 Section Safety	12
	1.2 Inspection Checkpoints	13
	Receiving Checkpoints	13
	Checking the Nameplate Data	13
2.	INSTALLATION.....	15
	2.1 Section Safety	16
	2.2 Checking Installation Site.....	17
	Installation Site	17
	Controlling the Ambient Temperature	17
	Protecting the Power Regenerative Unit from Foreign Matter	17
	2.3 Clearances	18
	2.4 Dimensions	19
	Models of 200 V/400 V 30 kW and Lower	19
	Models of 200 V/400 V 37 kW and Higher	19
	2.5 Removing and Replacing the Front Cover	21
	2.6 Removing and Replacing the LCD Monitor/Digital Operator.....	22
	Removing the LCD Monitor/Digital Operator	22
	Replacing the LCD Monitor/Digital Operator	22
3.	WIRING.....	23
	3.1 Section Safety	24
	3.2 Connection Diagram	25
	Connection Diagram with Drive	25
	3.3 Selecting Peripheral Devices	26
	Selecting Heavy Duty or Standard Duty RC5 Application	26
	Main Circuit Input Fuse	26
	Power Coordination and Current Suppression Reactors	27
	Wiring Precautions	28
	3.4 Wiring Main Circuit Terminals	29
	Required Wire Size	29
	Closed-Loop Connectors Size	31
	3.5 External Terminals.....	32
	Main Circuit Terminal Functions	32
	Control Circuit Terminal Functions	32

4.	OPERATION.....	33
	4.1 Section Safety	34
	4.2 Checks Prior to Main Power Application.	35
	4.3 Setting the Power Supply Voltage Jumper	36
	4.4 Using the Digital Operator	37
	4.5 Digital Operator Modes	39
	Modes	39
	Navigating Digital Operator Modes	40
	Operation Mode	42
	4.6 Power On/Off Sequence	43
	4.7 Run Command Selection	44
	Auto Run	44
	Manual Run	44
5.	MAINTENANCE AND INSPECTION.....	45
	5.1 Section Safety	46
	5.2 Periodic Inspection and Maintenance	47
	Daily Inspection	47
	Periodic Inspection	47
	Periodic Maintenance of Parts	47
6.	TROUBLESHOOTING	49
	6.1 Fault Detection.	50
	6.2 Minor Fault Detection	52
	6.3 Operation Errors	53
7.	SPECIFICATIONS	55
A.	PARAMETER LIST	59

Revision History

Preface

YASKAWA's RC5 is a power regenerative unit which has both braking and regenerative functions. This instruction manual describes installation, maintenance and inspection, troubleshooting, and specifications of the RC5. Read this instruction manual thoroughly before operation.

I.1 CONDITIONS OF ACCEPTABILITY	4
I.2 SAFETY INFORMATION	5
I.3 NOTES FOR SAFE OPERATION	6

i.1 Conditions of Acceptability

◆ NEC, CEC and UL Compliance

In order to comply with the NEC, CEC and UL, the following conditions of use must be strictly adhered to:

■ Surge Protector Installation

- An MOV must be installed on the input of the RC5 Unit.

■ Current Suppression Reactor Installation

- The Current Suppression Reactor must be installed as shown in [Figure 3.1](#).

■ Terminal Blocks

- The Power Terminal Blocks of the RC5 unit are for factory wiring use only.

■ Installation Environment

- Install the RC5 Unit in a protective enclosure suitable to its environment.

◆ CSA Standards Compliance

The RC5 is CSA certified as following.

■ Products

CLASS 3211 06

INDUSTRIAL CONTROL EQUIPMENT

Motor Controllers Miscellaneous

CLASS 2411 02

ELEVATOR EQUIPMENT

Enclosed Elevator and Escalator Electrical Equipment

■ Applicable Requirements

CAN/CSA C22.2 No.0.4-04

Bonding of Electrical Equipment

CAN/CSA C22.2 No.14-05

Industrial Control Equipment

CSA B44.1-04/ASME A17.5-2004

Elevator and Escalator Electrical Equipment



CSA B44.1 /
ASME A17.5

Figure i.1 CSA B44.1-04/ASME A17.5-2004 Mark

i.2 Safety Information

Read this instruction manual thoroughly before installation, operation, maintenance or inspection of the RC5. In this manual, NOTES FOR SAFE OPERATION are classified as “WARNING” or “CAUTION.”

◆ Supplemental Safety Information

General Precautions

- Some drawings in this manual are shown with the protective cover or shields removed, in order to describe detail with more clarity. Make sure all covers and shields are replaced before operating this product.
- This manual may be modified when necessary because of improvement of the product, modification, or changes in specifications.
- Such modifications are denoted by a revised manual No.
- To order a copy of this manual, if your copy has been damaged or lost, contact your YASKAWA representative.
- YASKAWA is not responsible for any modification of the product made by the user, since that will void your guarantee.

WARNING

Read and understand this manual before installing, operating or servicing this drive. The drive must be installed according to this manual and local codes.

The following conventions are used to indicate safety messages in this manual. Failure to heed these messages could result in serious or possibly even fatal injury or damage to the products or to related equipment and systems.

DANGER

Indicates a hazardous situation, which, if not avoided, will result in death or serious injury.

WARNING

Indicates a hazardous situation, which, if not avoided, could result in death or serious injury.

WARNING! will also be indicated by a bold key word embedded in the text followed by an italicized safety message.

CAUTION

Indicates a hazardous situation, which, if not avoided, could result in minor or moderate injury.

CAUTION! will also be indicated by a bold key word embedded in the text followed by an italicized safety message.

NOTICE

Indicates a property damage message.

NOTICE: will also be indicated by a bold key word embedded in the text followed by an italicized safety message.

Even items described in a Caution may result in a vital accident in some situations. In either case, follow these important notes.

Note: These are steps to be taken to insure proper operation.

i.3 Notes for Safe Operation

◆ Receiving

CAUTION

Do not install or operate any power regenerative unit which is damaged or has missing parts.

Failure to observe this caution may result in personal injury or equipment damage (Refer to page 12)

◆ Installation

CAUTION

Lift the cabinet by the base. When moving the unit, never lift by the front cover or the front panel.

Otherwise, the main unit may be dropped causing damage to the unit. (Refer to page 16)

Mount the power regenerative unit on nonflammable material (i.e. metal).

Failure to observe this caution can result in a fire. (Refer to page 16)

When mounting units in an enclosure, install a fan or other cooling device to keep the intake air temperature below 45°C.

Overheating may cause a fire or damage to the unit. (Refer to page 16)

In order to comply to UL regulations, the MOV and current suppression reactor must be installed on the input of the R5 unit.

Refer to the installation diagram. (Refer to page 16)

◆ Wiring

WARNING

Only commence wiring after verifying that the power supply is turned OFF.

Failure to observe this warning can result in an electric shock or a fire. (Refer to page 24)

Wiring should be performed only by qualified personnel.

Failure to observe this warning can result in an electric shock or a fire. (Refer to page 24)

Make sure to ground the ground terminal ⊕ before connecting the other terminals.

Failure to observe this warning can result in an electric shock or a fire. (Refer to page 24)

Install adequate branch short circuit protection according to applicable codes.

Failure to comply could result in damage to the drive.

The device is suitable for circuits capable of delivering up to 100 kA RMS Symmetrical Amperes, 240 Vac maximum (200 V Class), 480 Vac maximum (400 V Class) or equivalent to the SCCR rating of the VFD to which it is connected - whichever value is less.

R5 Series of Power Regenerative devices shall be connected to a VFD which incorporates Solid State Short Circuit Protection Circuitry and was found to comply with the High Fault Current Short Circuit Test.

CAUTION

Verify that the power regenerative unit rated voltage coincides with the AC power supply voltage.

Failure to observe this caution can result in personal injury or a fire. (Refer to page 24)

Do not perform a withstand voltage test of the power regenerative unit.

It may cause semi-conductor elements to be damaged. (Refer to page 24)

Connect the power coordinating reactor and the power suppressing reactor as described in this instruction manual.

Improper connection may cause a fire. (Refer to page 24)

Verify that the rated voltage of the power regenerative unit coincides with the rated voltage of the power regenerative unit to be connected.

Failure to observe this caution can result in a fire. (Refer to page 24)

Tighten terminal screws.

Failure to observe this caution can result in a fire. (Refer to page 24)

◆ Operation

WARNING

Only turn ON the input power supply after replacing the front cover or the terminal cover. Do not remove the cover while power is on.

Failure to observe this warning can result in an electric shock. (Refer to page 34)

Never operate the digital operator or other switches when your hand is wet.

Failure to observe this warning can result in an electric shock. (Refer to page 34)

Never touch the terminals while power is on, even if the power regenerative unit stops.

Failure to observe this warning can result in an electric shock. (Refer to page 34)

CAUTION

Never touch the heatsink or input reactors since their temperature may be very high.

Failure to observe this caution can result in harmful burns to the body. (Refer to page 34)

All the parameters of the power regenerative unit have been preset at the factory. Do not change the settings unnecessarily.

The power regenerative unit may be damaged. (Refer to page 34)

◆ Maintenance and Inspection

WARNING

Never touch high-voltage terminals in the power regenerative unit.

Failure to observe this warning can result in an electric shock. (Refer to page 46)

Perform maintenance or inspection only after verifying that the CHARGE LED goes OFF, after the main circuit power supply is turned OFF.

The capacitors are still charged and can be dangerous. (Refer to page 46)

Only authorized personnel should be permitted to perform maintenance, inspections or parts replacement.

[Remove all metal objects (watches, bracelets, etc.) before operation.] (Use tools which are insulated against electric shock.)

Failure to observe this warning can result in an electric shock. (Refer to page 46)

Never modify the product.

Failure to observe this warning can result in an electric shock or personal injury and will invalidate the guarantee. (Refer to page 46)

CAUTION

The power regenerative unit employs semi-conductor elements. Do not touch the CMOS elements.

They are easily damaged by static electricity. (Refer to page 46)

Do not connect or disconnect wires or connectors while power is applied to the circuit.

Failure to observe this caution can result in personal injury. (Refer to page 46)

◆ Warning Label

A warning label is displayed on the front cover of the power regenerative unit, as shown below. Follow these instructions when handling the power regenerative unit.

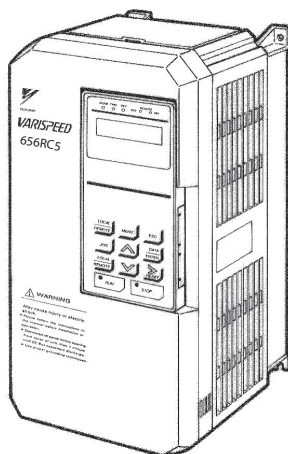

Model CIMR-R5U23P7

■ Warning Label

	WARNING - Risk of electric shock.
	<p>Read manual before installing. Wait 5 minutes for capacitor discharge after disconnecting power supply. To conform to CE requirements, make sure to ground the supply neutral.</p>
	AVERTISSEMENT - Risque de décharge électrique
	<p>Lisez le manuel avant installation. Attendez 5 minutes après la coupure de l'alimentation électrique afin que les condensateurs soient complètement déchargés. Assurez vous de connecter a la masse le fil du neutre afin d'être en accord avec la réglementation CE.</p>
	危険 - けが・感電のおそれがあります。
	<ul style="list-style-type: none"> ・据え付け、運転の前には必ず取扱説明書をお読み下さい。 ・通電中及び電源遮断後5分以内は表面カバーを外さないでください。 ・電源の中性点を接地して下さい。(CE対応)

Receiving

This chapter describes how to verify the RC5 after delivery to the user.

1.1 SECTION SAFETY	12
1.2 INSPECTION CHECKPOINTS	13

1.1 Section Safety

 **CAUTION**

Do not install or operate any power regenerative unit which is damaged or has missing parts.

Failure to observe this caution may result in personal injury or equipment damage.

1.2 Inspection Checkpoints

◆ Receiving Checkpoints

Table 1.1 Checkpoints

Checkpoints	Description
Does the power regenerative unit model number correspond with the purchase order?	Check the model number on the nameplate on the side of the RC5. (Refer to <i>Figure 1.2</i> .)
Are any parts damaged?	Visually check the exterior and verify that there was no damage during transport.
Is hardware properly seated and securely tightened?	Remove the front cover of the power regenerative unit. Check all visible hardware with appropriate tools.

If any of the above checkpoints are not satisfactory, contact your YASKAWA representative.

◆ Checking the Nameplate Data

■ Nameplate Data

Example of standard domestic model CIMR-R5U2011.

Power Regenerative Unit Model	MODEL : CIMR-R5U2011	SPEC : 20111A
Input Spec.	INPUT : AC 3PH 200 - 220V 50/60 Hz	30A 1min 25%ED 24A 80% CONT.
Output Spec.	OUTPUT : DC 300 - 340V	37A 1min 25%ED 30A 80% CONT.
LOT No.	LOT NO:	MASS: 5.5 kg ← Mass
Serial No.	SER NO: N5W2130-3-002 /V0512	
		FILE NO: E131457
	YASKAWA ELECTRIC CORPORATION MADE IN JAPAN	

Figure 1.1 Nameplate Data

■ Model Designation

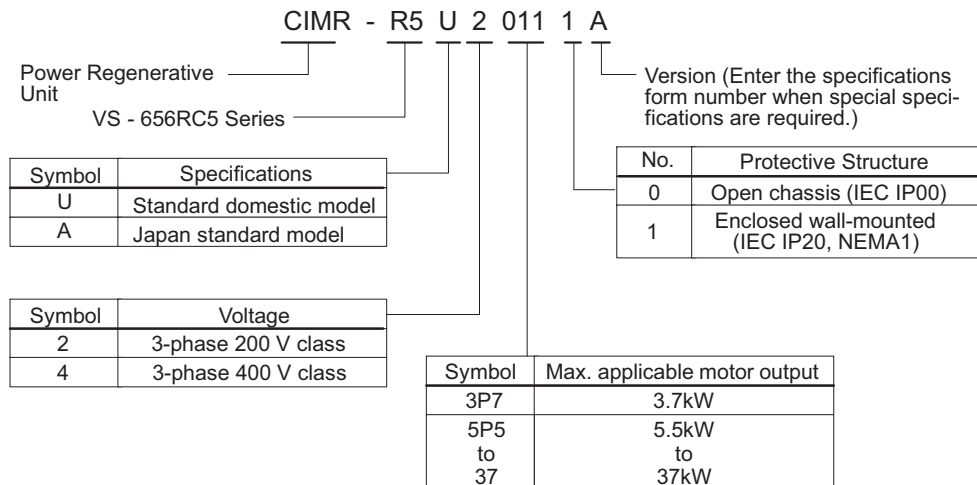

"P" indicates the decimal point.

Figure 1.2 Model Designation

■ Protective Structure

- Open Chassis Type (IEC IP00)
Protected so that parts of the human body cannot reach electrically charged parts from the front when the Power regenerative unit is mounted in a control panel.
- Enclosed Wall-mounted Type (IEC IP20, NEMA 1)
The power regenerative unit is structured so that the power regenerative unit is shielded from the exterior, and can thus be mounted to the interior wall of a standard building (not necessarily enclosed in a control panel). The protective structure conforms to the standards of NEMA 1 in the USA.

1.2 Inspection Checkpoints

This page intentionally blank.

Installation

This chapter describes the configuration, location and space when mounting the RC5.

2.1 SECTION SAFETY	16
2.2 CHECKING INSTALLATION SITE	17
2.3 CLEARANCES	18
2.4 DIMENSIONS	19
2.5 REMOVING AND REPLACING THE FRONT COVER	21
2.6 REMOVING AND REPLACING THE LCD MONITOR/DIGITAL OPERATOR	22

2.1 Section Safety

 **CAUTION**

Lift the cabinet by the base. When moving the unit, never lift by the front cover or the front panel.

Otherwise, the main unit may be dropped causing damage to the unit.

Mount the power regenerative unit on nonflammable material (i.e. metal).

Failure to observe this caution can result in a fire.

When mounting units in an enclosure, install a fan or other cooling device to keep the intake air temperature below 45°C.

Overheating may cause a fire or damage to the unit.

2.2 Checking Installation Site

◆ Installation Site

Install the power regenerative unit under the following conditions.

NOTICE: Do not install the power regenerative unit to an area greater than pollution degree 2 (UL standard).

Type	Ambient Operating Temperature	Humidity
Enclosed wall-mounted	-10 to +40°C	90% RH or less (no condensation)
Open chassis	-10 to +45°C	90% RH or less (no condensation)

Protection covers are attached to the top and bottom of the power regenerative unit. Be sure to remove the protection covers before installing a 200 or 400 V Class power regenerative unit with an output of 30 kW or less in a panel.

To ensure proper performance and long operating life, follow the recommendations below when choosing a location for installing the RC5. Make sure the power regenerative unit is protected from the following conditions:

- Extreme cold and heat.
Use only within ambient temperature range: -10°C to +40°C
- Rain, moisture. (For enclosed wall-mounted type)
- Oil sprays, splashes
- Salt spray.
- Direct sunlight. (Avoid using outdoors.)
- Corrosive gases or liquids.
- Dust or metallic particles in the air. (For enclosed wall-mounted type)
- Physical shock, vibration.
- Magnetic noise. (Example: welding machines, power devices, etc.)
- High humidity.
- Radioactive materials.
- Combustibles: thinners, solvents, etc.

◆ Controlling the Ambient Temperature

To enhance the reliability of operation, the power regenerative unit should be installed in an environment free from extreme temperature increases. If the power regenerative unit is installed in an enclosed environment, such as a box, use a cooling fan or air conditioner to maintain the internal air temperature below 45°C.

◆ Protecting the Power Regenerative Unit from Foreign Matter

Place a cover over the power regenerative unit during installation to shield it from metal power produced by drilling.

Always remove the cover from the power regenerative unit after completing installation. Otherwise, ventilation will be reduced, causing the power regenerative unit to overheat.

2.3 Clearances

Install the RC5 vertically and allow sufficient clearances for effective cooling as shown in *Figure 2.1*.

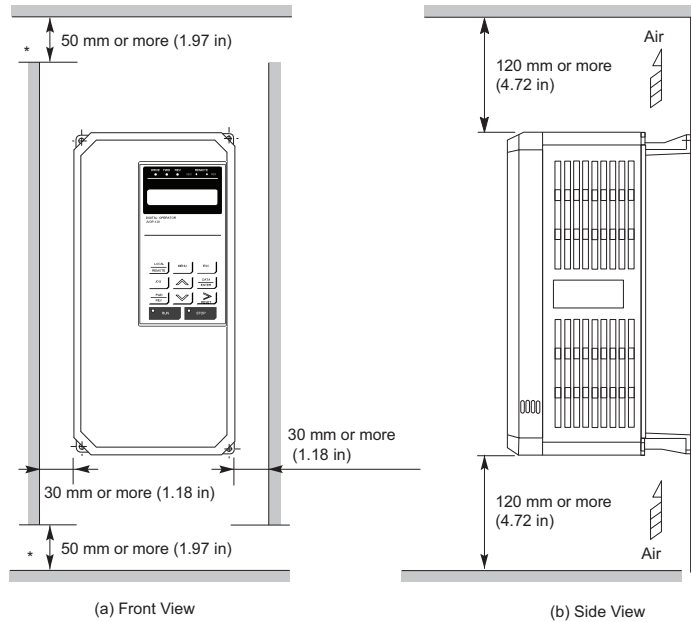

Figure 2.1 Clearances

- Note:**
1. The clearances required at top/bottom and both sides are common in open chassis type (IP00) and enclosed wall-mounted type (NEMA 1).
 2. Remove the top and bottom covers to use the open chassis type of 200 V/400 V 30 kW or less.
 3. When installing the models of 200 V/400 V 37 kW or more equipped with eyebolts, extra spacing will be required on either side. For detailed dimensions, contact your YASKAWA representative.
 4. Ensure sufficient space for the sections at the upper and lower parts marked with * in order to permit the flow of intake/exhaust air to / from the unit.

2.4 Dimensions

◆ Models of 200 V/400 V 30 kW and Lower

Figure 2.2 shows a 200 V 3.7 kW model. Use open chassis type 200 V/400 V 30 kW and lower with the top and bottom covers removed.

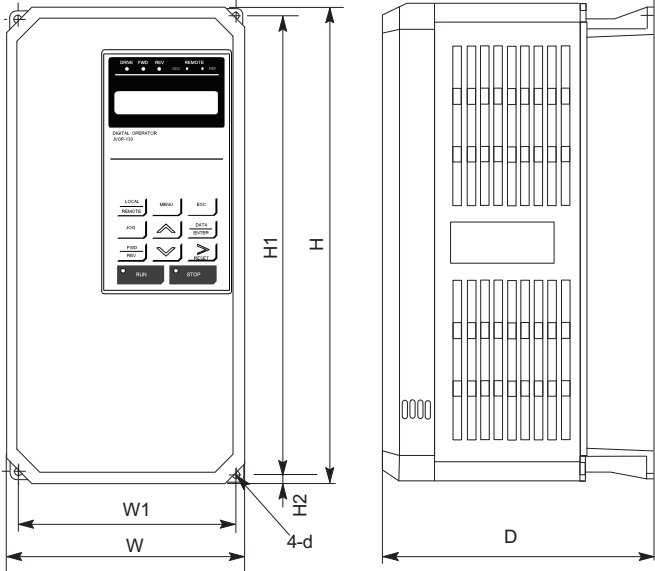

Figure 2.2 Dimensions of RC5

◆ Models of 200 V/400 V 37 kW and Higher

Figure 2.3 shows a 200 V 37 kW model.

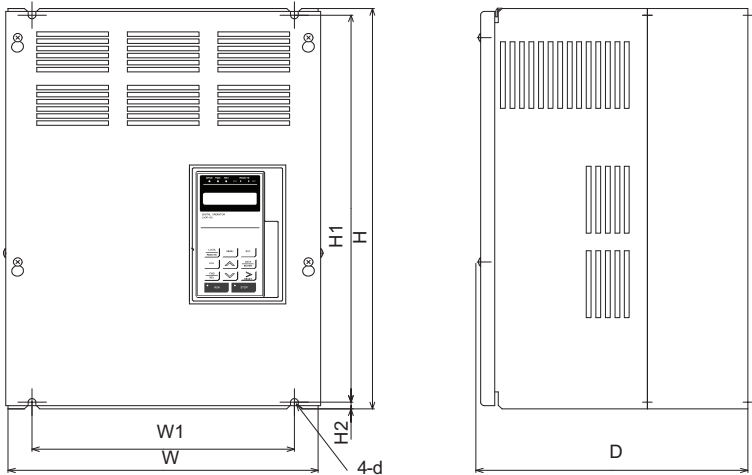

Figure 2.3

2.4 Dimensions

Table 2.1 RC5 Dimensions mm (in) and Approx. Mass (kg)

Voltage	RC5 CIMR-R5U□	Dimensions mm (in)			Mounting Dimension mm (in)			Approx. Mass (kg)	Mounting Hole d	Enclosure Type
		W	H	D	W1	H1	H2			
200V Class	23P7	140 (5.51)	280 (11.02)	180 (7.09)	126 (4.96)	266 (10.47)	7.0 (0.28)	4.5	M5	IP20
	25P5									
	27P5									
	2011	200 (7.87)	300 (11.81)	205 (8.07)	186 (7.32)	285 (11.22)	8.0 (0.32)	5.5	M6	
	2015									
	2018	250 (9.84)	380 (14.96)	225 (8.86)	236 (9.29)	365 (14.37)	7.5 (0.30)	10		
	2022									
	2030						400 (15.75)	27.5 (1.08)		
2037	325 (12.80)	450 (17.72)	285 (11.22)	275 (10.83)	435 (17.13)	7.5 (0.30)	23			IP00
400V Class	43P7	140 (5.51)	280 (11.02)	180 (7.09)	126 (4.96)	266 (10.47)	7.0 (0.28)	3.5	M5	IP20
	45P5							4		
	47P5									
	4011	200 (7.87)	300 (11.81)	205 (8.07)	186 (7.32)	285 (11.22)	8.0 (0.32)	6	M6	
	4015									
	4018	250 (9.84)	380 (14.96)	225 (8.86)	236 (9.29)	365 (14.37)	7.5 (0.30)	10.5		
	4022									
	4030									
400V Class	4037	325 (12.80)	450 (17.72)	285 (11.22)	275 (10.83)	435 (17.13)	7.5 (0.30)	25		M6
	4045			285 (11.22)	275 (10.83)			26		
	4055		635 25.0)	285 (11.22)	275 (10.83)	610 (24.02)		34		
	4075			285 (11.22)	275 (10.83)			36		

Note: RC5 is offered in the following enclosure types:

- IP20: 23P7 to 2030
- IP20: 43P7 to 4030
- IP00: 2037
- IP00: 4037 to 4075

2.5 Removing and Replacing the Front Cover

To remove the front cover, first move the LCD monitor/digital operator in the direction shown by arrow 1. Then squeeze the cover in the direction shown by arrows 2 on both sides and lift in the direction shown by arrow 3.

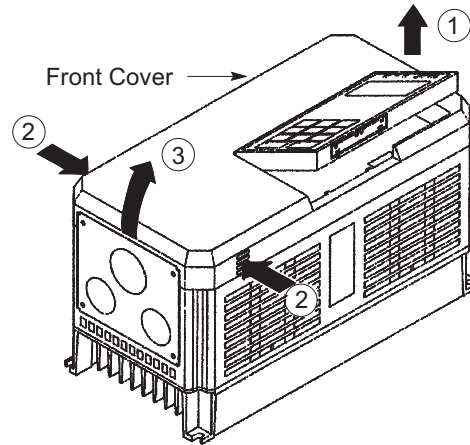

Figure 2.4 Removing and Replacing the Front Cover

Note: Do not replace the front cover with the LCD monitor/digital operator connected. The LCD monitor/digital operator will not be connected to the power regenerative unit. Replace the front cover first and then install the LCD monitor/digital operator on the cover. [Refer to Removing and Replacing the LCD Monitor/Digital Operator on page 22](#) for replacing the LCD monitor/digital operator.

2.6 Removing and Replacing the LCD Monitor/Digital Operator

Remove and replace the LCD monitor/digital operator as follows.

◆ Removing the LCD Monitor/Digital Operator

Push the LCD monitor/digital operator lever in the direction shown by arrow 1 and lift the LCD monitor/digital operator in the direction shown by arrow 2 to remove the LCD monitor/digital operator from the front cover.

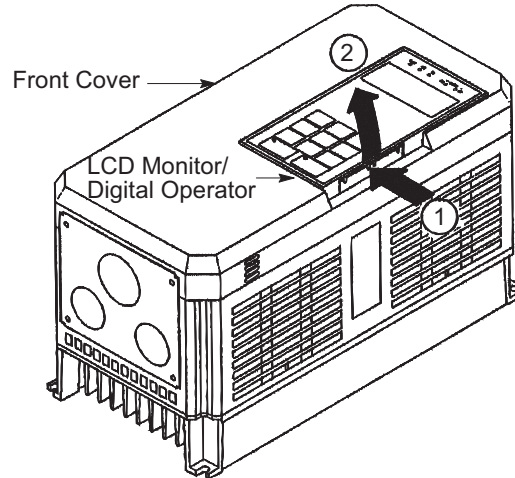

Figure 2.5 Removing the LCD Monitor/Digital Operator

◆ Replacing the LCD Monitor/Digital Operator

Engage the LCD monitor/digital operator on claws A in the direction shown by arrow 1 and then on claws B in the direction shown by arrow 2 to lock the LCD monitor/digital operator.

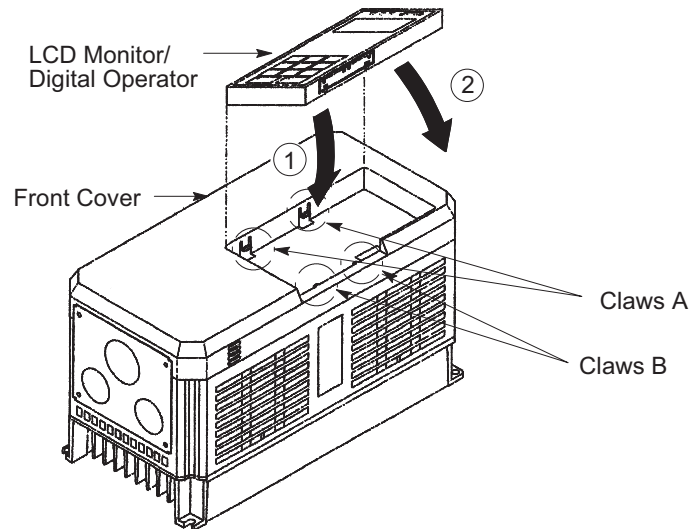

Figure 2.6 Replacing the LCD Monitor/Digital Operator

Note: Never fit the LCD monitor/digital operator in any other direction or by any other method. The LCD monitor/digital operator will not be connected to the inverter.

Wiring

3.1 SECTION SAFETY	24
3.2 CONNECTION DIAGRAM	25
3.3 SELECTING PERIPHERAL DEVICES	26
3.4 WIRING MAIN CIRCUIT TERMINALS	29
3.5 EXTERNAL TERMINALS	32

3.1 Section Safety

WARNING

Only commence wiring after verifying that the power supply is turned OFF.

Failure to observe this warning can result in an electric shock or a fire.

Wiring should be performed only by qualified personnel.

Failure to observe this warning can result in an electric shock or a fire.

Make sure to ground the ground terminal ⊕ before connecting the other terminals.

Failure to observe this warning can result in an electric shock or a fire.

Install adequate branch short circuit protection according to applicable codes.

Failure to comply could result in damage to the drive.

The device is suitable for circuits capable of delivering up to 100 kA RMS Symmetrical Amperes, 240 Vac maximum (200 V Class), 480 Vac maximum (400 V Class) or equivalent to the SCCR rating of the VFD to which it is connected - whichever value is less.

R5 Series of Power Regenerative devices shall be connected to a VFD which incorporates Solid State Short Circuit Protection Circuitry and was found to comply with the High Fault Current Short Circuit Test.

CAUTION

Verify that the power regenerative unit rated voltage coincides with the AC power supply voltage.

Failure to observe this caution can result in personal injury or a fire.

Do not perform a withstand voltage test of the power regenerative unit.

It may cause semi-conductor elements to be damaged.

Connect the power coordinating reactor and the power suppressing reactor as described in this instruction manual.

Improper connection may cause a fire.

Verify that the rated voltage of the power regenerative unit coincides with the rated voltage of the power regenerative unit to be connected.

Failure to observe this caution can result in a fire.

Tighten terminal screws.

Failure to observe this caution can result in a fire.

3.2 Connection Diagram

◆ Connection Diagram with Drive

Figure 3.1 shows a diagram of a typical connection of the RC5 with the Yaskawa AC Drive.

Note: The RC5 is compatible with other Yaskawa drive (inverter) products. Refer to the application technical manual for the equivalent connection diagram.

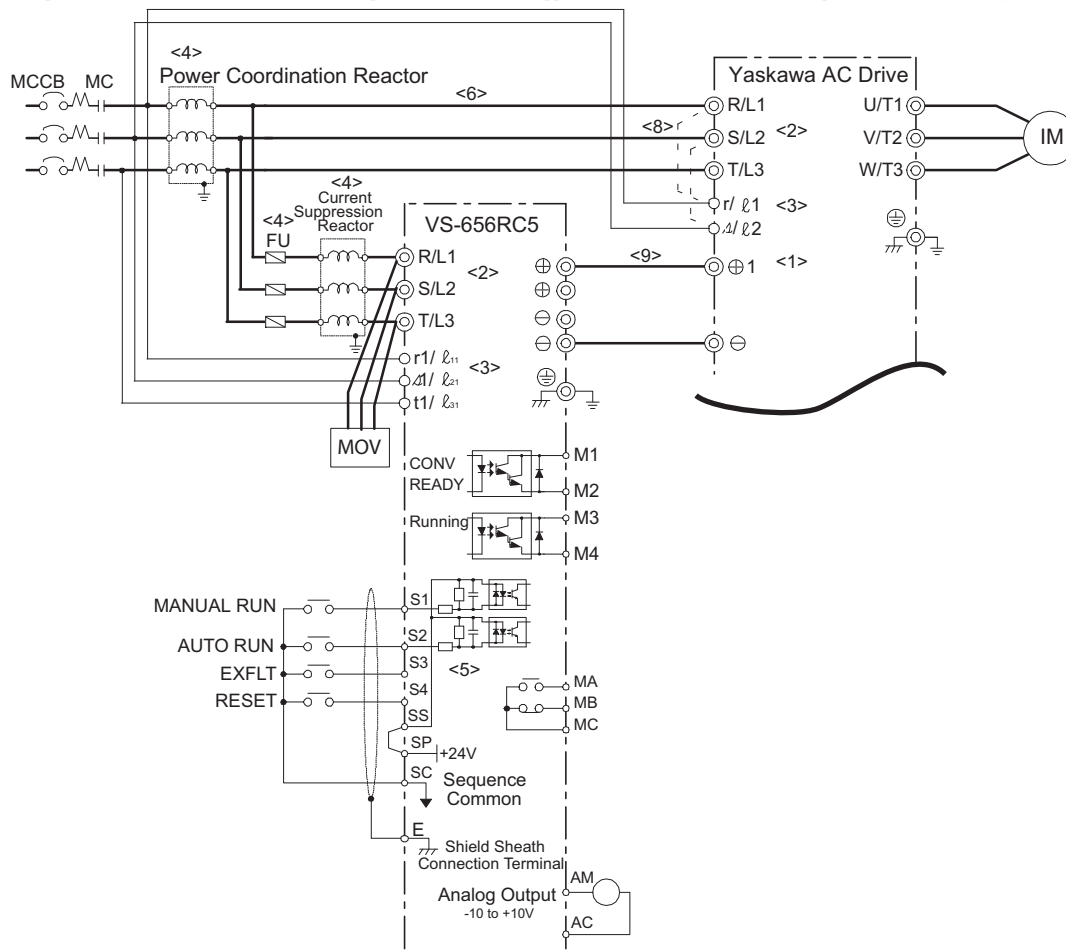

Figure 3.1 Connection Diagram (When connecting a RC5 and a Yaskawa AC Drive)

<1> Connect to the terminal (+)1 for 200 V class 0.4 to 22 kW, and 400 V class 0.4 to 45 kW Yaskawa AC drive. Use terminal (+)3 for 200 V class 30 to 37 kW, and 400 V class 55 to 75 kW VS-616G5 drivers or another Yaskawa drive (inverter) product.

<2> Connect the Yaskawa AC Drive power supply terminals R/L1, S/L2, and T/L3 to the secondary side of the power coordinating reactor. Connect the RC5 AC power supply terminals R/L1, S/L2, and T/L3 to the secondary side of the power suppressing reactor.

<3> Connect terminals r/l 1, s/l 2 of VS-616G5, and terminals r1/l 11, s 1/l 21, and t1/l 31 of the RC5 to the primary side of the power coordinating reactor.

<4> Make sure to use the specified reactor, fuse and fuse holder.

<5> The sequence input terminal of RC5 is the same as terminal S1.

<6> The wiring distance between the power coordinating reactor, and RC5 and a Yaskawa AC Drive should be 10 m or less.

<7> DC bus wiring [(+) 1 - (+), ⊖ ⊖] between the Drive and the power regenerative unit should be 5 m or less.

<8> Remove the wiring of terminals r/l 1 and s/l 2 since they were connected at the factory.

<9> If installing a circuit breaker or a magnetic contactor on the RC5 output (DC) side to shut down the power supply in an emergency, observe the following precautions.

- Be sure to confirm that the charge lamps on the RC5 and the Inverter are not lit, and then turn on the circuit breaker or contactor. If the circuit breaker or contactor is turned on while power is supplied to the RC5 and the Inverter, an overcurrent may occur and damage the circuit breaker or contactor.
- Be sure to confirm that the circuit breaker or contactor is turned on before the power is turned on for the RC5.

3.3 Selecting Peripheral Devices

Selecting Heavy Duty or Standard Duty RC5 Application

The RC5 overload rating has the capability of 150% braking torque for 30 seconds and 200% peak braking torque. The overload capability is based on the standard duty rating. The RC5 overload rating can be applied to heavy duty applications. The following is a description of the heavy duty and standard duty ratings.

■ Heavy Duty

Heavy duty applications require continuous energy dissipation (100% braking torque).

The overload rating is 125% for 60 seconds with a duty cycle of 25%. Braking torque of 187.5% is available for 30 seconds. Please note the peak torque should be less than 250%.

The RC5 requires selecting Power Coordination and Current Suppression reactors according to specifications in [Table 3.3](#).

■ Standard Duty

Standard duty applications require intermittent full energy dissipation. The continuous rating is 80% or less braking torque and 100% braking torque for 60 seconds with a duty cycle of 25% (60 seconds maximum on-time of every 240 seconds). The overload rating is 150% braking torque for 30 seconds. Please note the peak torque should be less than 200%.

The RC5 requires selecting Power Coordination and Current Suppression reactors according to specifications in [Table 3.3](#)

◆ Main Circuit Input Fuse

■ Fuse Kits

The Fuse Kit is sized for both Heavy Duty and Standard Duty applications.

Connect a fuse at the primary side of the power suppression reactor. Recommended fuses are shown in [Table 3.1](#) and [Table 3.2](#).

Table 3.1 200 V Class Input Fuse

RC5			Input fuse			Fuse holder		
Model CIMR-R5U□	Rated regenerative capacity (kW) 25%ED	Rated input current (Aac) 25%ED	Yaskawa Part Number	Ferraz Part Number	Amount per unit	Yaskawa Part Number	Ferraz Part Number	Amount per unit
23P71A	2.2	10	UFU000151	A30QS20-1	3	UFU000157	70318	1
25P51A	3.7	15	UFU000152	A30QS30-1	3	UFU000157	70318	1
27P51A	5.5	20	UFU000152	A30QS30-1	3	UFU000157	70318	1
20111A	7.5	30	UFU000153	A30QS50-4	3	FU-002082	P243G	3
20151A	11	40	UFU000154	A30QS80-4	3	FU-002083	P243	3
20181A	15	50	UFU000154	A30QS80-4	3	FU-002083	P243	3
20221A	18	60	UFU000155	A30QS100-4	3	FU-002083	P243	3
20301A	22	80	UFU000156	A30QS150-4	3	FU-002083	P243	3
20370A	30	100	UFU000156	A30QS150-4	3	FU-002083	P243	3

Note: These fuses and fuse holders are made by FERRAZ.

Table 3.2 400 V Class Input Fuse

RC5			Input fuse			Fuse holder		
Model CIMR-R5U□	Rated regenerative capacity (kW) 25%ED	Rated input current (Aac) 25%ED	Yaskawa Part Number	Ferraz Part Number	Amount per unit	Yaskawa Part Number	Ferraz Part Number	Amount per unit
43P71A	2.2	5	FU-002029	A60Q10-2	3	FU-002055	30323	1
45P51A	3.7	7.5	FU-002030	A60Q15-2	3	FU-002055	30323	1
47P51A	5.5	10	FU-002030	A60Q15-2	3	FU-002055	30323	1
40111A	7.5	15	FU-002032	A60Q30-2	3	FU-002055	30323	1
40151A	11	20	FU-002032	A60Q30-2	3	FU-002055	30323	1
40181A	15	25	FU-000783	A50P50-4	3	FU-002082	P243G	3
40221A	18	30	FU-000783	A50P50-4	3	FU-002082	P243G	3
40301A	22	40	FU-000806	A50P80-4	3	FU-002084	P243E	3
40370A	30	50	FU-000806	A50P80-4	3	FU-002084	P243E	3
40450A	37	60	FU-000807	A50P100-4	3	FU-002084	P243E	3
40550A	45	75	FU-000809	A50P150-4	3	FU-002084	P243E	3
40750A	55	100	FU-000809	A50P150-4	3	FU-002084	P243E	3

Note: These fuses and fuse holders are made by FERRAZ.

◆ Power Coordination and Current Suppression Reactors

Both Power Coordination and Current Suppression Reactors are 3-phase input reactors that correspond to each RC5 model and are necessary when operating the RC5. Use a single Power Coordination and a single Current Suppression reactor for each RC5 application.

■ Recommended RC5 Power Coordination and Suppression Reactor Specifications

Table 3.3 shows Yaskawa recommended specifications for Power Coordination and Current Suppression reactors for each RC5 model.

Table 3.3 Recommended RC5 Power Coordination and Suppression Reactor Specifications

RC5		Power Coordination Reactor		Current Suppression	
Model CIMR-R5U□		Rated Current (Arms)	Inductance (mH)	Rated Current (Arms)	Inductance (mH)
200 V Class	23P71A	20	0.53	15	0.31
	25P51A	30	0.35	15	0.31
	27P51A	40	0.265	20	0.15
	20111A	60	0.18	40	0.1
	20151A	80	0.13	40	0.1
	20181A	90	0.12	50	0.06
	20221A	120	0.09	60	0.05
	20301A	160	0.07	80	0.04
	20370A	200	0.05	100	0.03
400 V Class	43P71A	10	2.2	7.5	1.2
	45P51A	15	1.42	7.5	1.2
	47P51A	20	1.06	10	0.6
	40111A	30	0.7	15	0.4
	40151A	40	0.53	25	0.3
	40181A	50	0.42	25	0.3
	40221A	60	0.36	30	0.2
	40301A	80	0.26	40	0.15
	40370A	90	0.24	50	0.12
	40450A	120	0.18	60	0.1
	40550A	150	0.15	75	0.08
40750A	200	0.11	100	0.06	

3.3 Selecting Peripheral Devices

◆ Wiring Precautions

The external interconnection wiring must be performed with following procedures. After completing RC5 interconnections, be sure to check that the connections are correct. Never use control circuit buzzer check.

■ Precautions on Control Circuit Wiring

- Separate control circuit wires from main circuit wires and other power cables to prevent erroneous operation caused by noise interference.
- Separate the wiring of control circuit terminals from other control terminals or main circuit wirings.
- Wiring distance should be less than 50 m.
- Insert the wire into the lower part of the terminal block and connect it tightly with a screwdriver. Wire sheath strip length must be 7 mm.

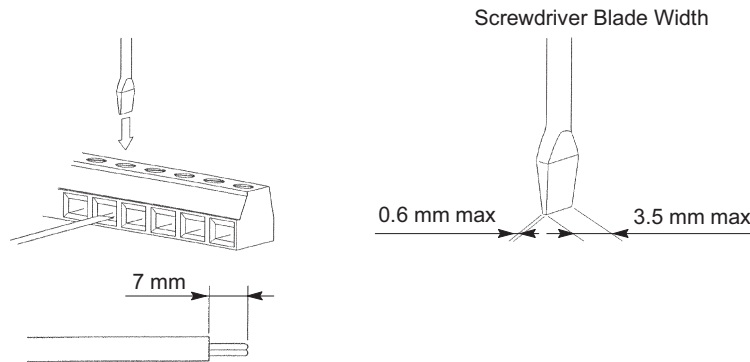

Figure 3.2 Control Circuit Terminal Wiring

- Use twisted shielded or twisted-pair shielded wire for the control circuit line and connect the shielded sheath to inverter terminal E. (See [Figure 3.3](#))

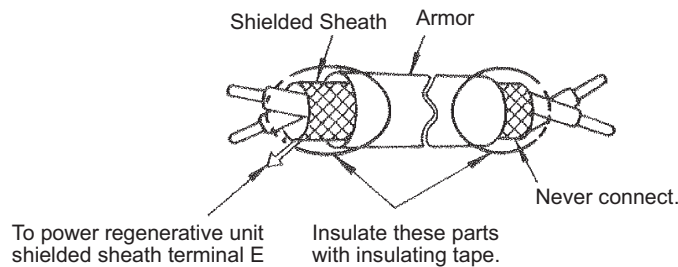

Figure 3.3 Shielded Wire Termination

■ Ground Wiring

- Do not share the ground wire with other devices, such as welding machines or power tools. Separate the grounding cables from the wirings for power tools.
- Always use a ground wire that complies with technical standards on electrical equipment and minimize the length of the ground wire. Leakage current flows through the power regenerative unit. Therefore, if the distance between the ground electrode and the ground terminal is too long, potential on the ground terminal of the power regenerative unit will become unstable.
- When using more than one power regenerative unit, be careful not to loop the ground wire.

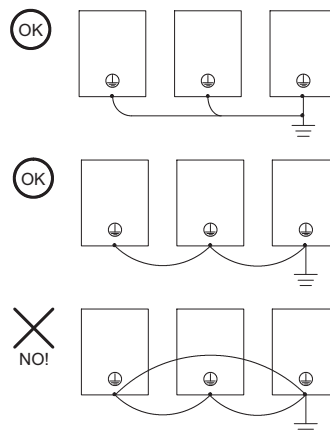

Figure 3.4 Ground Wiring

3.4 Wiring Main Circuit Terminals

◆ Required Wire Size

Select wires to be used for wiring from [Table 3.4](#) and [Table 3.5](#).

Table 3.4 200 V Class Wire Size

Circuit	RC5 CIMR-R5U□	Terminal Symbol	Terminal Screw	Wire Size <1>		Wire Type
				mm ²	AWG	
Main	23P7	R/L1, S/L2, T/L3, (+), (+), ⊖, ⊖	M4	2 to 5.5	14 to 10	Power cable: 600 V vinyl sheathed wire or equivalent
		r1/ℓ11, Δ1/ℓ21, t1/ℓ31				
		⊕				
	25P5	R/L1, S/L2, T/L3, (+), (+), ⊖, ⊖	M4	3.5 to 5.5	12 to 10	
		r1/ℓ11, Δ1/ℓ21, t1/ℓ31		2 to 5.5	14 to 10	
		⊕		3.5 to 5.5	12 to 10	
	27P5	R/L1, S/L2, T/L3, (+), (+), ⊖, ⊖	M4	5.5	10	
		r1/ℓ11, Δ1/ℓ21, t1/ℓ31		2 to 5.5	14 to 10	
		⊕		3.5 to 5.5	12 to 10	
	2011	R/L1, S/L2, T/L3, (+), (+), ⊖, ⊖	M5	8	8	
		r1/ℓ11, Δ1/ℓ21, t1/ℓ31		2 to 5.5	14 to 10	
		⊕		5.5 to 8	10 to 8	
	2015	R/L1, S/L2, T/L3, (+), (+), ⊖, ⊖	M5	8	8	
		r1/ℓ11, Δ1/ℓ21, t1/ℓ31		2 to 5.5	14 to 10	
		⊕		5.5 to 8	10 to 8	
	2018	R/L1, S/L2, T/L3, (+), (+), ⊖, ⊖	M8	22	4	
		r1/ℓ11, Δ1/ℓ21, t1/ℓ31	M4	2 to 5.5	14 to 10	
		⊕	M6	8	8	
	2022	R/L1, S/L2, T/L3, (+), (+), ⊖, ⊖	M8	22	4	
		r1/ℓ11, Δ1/ℓ21, t1/ℓ31	M4	2 to 5.5	14 to 10	
		⊕	M6	8	8	
	2030	R/L1, S/L2, T/L3, (+), (+), ⊖, ⊖	M8	30 to 38	3 to 2	
		r1/ℓ11, Δ1/ℓ21, t1/ℓ31	M4	2 to 5.5	14 to 10	
		⊕	M6	14	6	
2037	R/L1, S/L2, T/L3, (+), (+), ⊖, ⊖	M8	50 to 60	1 to 1/0		
	r1/ℓ11, Δ1/ℓ21, t1/ℓ31	M4	2 to 5.5	14 to 10		
	⊕	M6	14	6		
Control	Common to all models	S1, S2, S3, S4, SS, SP, SC, M1, M2, M3, M4, MA, MB, MC, AM, AC	—	twisted wire 0.5 to 1.25 single 0.5 to 1.25	twisted wire 20 to 16 single 20 to 16	Shielded twisted-pair wires
		E (G)	M3.5	0.5 to 2	20 to 14	

<1> Wire size is determined by 75°C temperature-rated copper wire.

Note: Cable size is selected assuming external wiring of single 3-core cables at an ambient temperature of 30°C.

Note: For model number 2015, use closed-loop connectors that are recommended by JST (JST 14-5).

3.4 Wiring Main Circuit Terminals

Table 3.5 400 V Class Wire Size

Circuit	RC5 CIMR-R5U□	Terminal Symbol	Terminal Screw	Wire Size <1>		Wire Type
				mm ²	AWG	
Main	43P7	R/L1, S/L2, T/L3, (+), (+), (+), ⊖, ⊖	M4	2 to 5.5	14 to 10	Power cable: 600 V vinyl sheathed wire or equivalent
		r1/l11, s1/l21, t1/l31				
		⊕				
	45P5	R/L1, S/L2, T/L3, (+), (+), (+), ⊖, ⊖	M4	2 to 5.5	14 to 10	
		r1/l11, s1/l21, t1/l31				
		⊕				
	47P5	R/L1, S/L2, T/L3, (+), (+), ⊖, ⊖	M4	2 to 5.5	14 to 10	
		r1/l11, s1/l21, t1/l31				
		⊕				
	4011	R/L1, S/L2, T/L3, (+), (+), ⊖, ⊖	M5	3.5 to 5.5	12 to 10	
		r1/l11, s1/l21, t1/l31		2 to 5.5	14 to 10	
		⊕				
	4015	R/L1, S/L2, T/L3, (+), (+), ⊖, ⊖	M5	5.5	10	
		r1/l11, s1/l21, t1/l31		2 to 5.5	14 to 10	
		⊕		5.5	10	
	4018	R/L1, S/L2, T/L3, (+), (+), ⊖, ⊖	M6	8 to 14	8 to 6	
		r1/l11, s1/l21, t1/l31	M4	2 to 5.5	14 to 10	
		⊕	M6	8	8	
	4022	R/L1, S/L2, T/L3, (+), (+), ⊖, ⊖	M6	8 to 14	8 to 6	
		r1/l11, s1/l21, t1/l31	M4	2 to 5.5	14 to 10	
		⊕	M6	8	8	
	4030	R/L1, S/L2, T/L3, (+), (+), ⊖, ⊖	M6	14	6	
		r1/l11, s1/l21, t1/l31	M4	2 to 5.5	14 to 10	
		⊕	M6	8	8	
4037	R/L1, S/L2, T/L3, (+), (+), ⊖, ⊖	M6	14 to 22	6 to 4		
	r1/l11, s1/l21, t1/l31	M4	2 to 5.5	14 to 10		
	⊕	M6	8	8		
4045	R/L1, S/L2, T/L3, (+), (+), ⊖, ⊖	M8	22 to 38	4 to 2		
	r1/l11, s1/l21, t1/l31	M4	2 to 5.5	14 to 10		
	⊕	M6	8	8		
4055	R/L1, S/L2, T/L3, (+), (+), ⊖, ⊖	M8	38 to 60	2 to 1/0		
	r1/l11, s1/l21, t1/l31	M4	2 to 5.5	14 to 10		
	⊕	M6	14	6		
4075	R/L1, S/L2, T/L3, (+), (+), ⊖, ⊖	M8	50 to 60	1 to 1/0		
	r1/l11, s1/l21, t1/l31	M4	2 to 5.5	14 to 10		
	⊕	M6	14	6		
Control	Common to all models	S1, S2, S3, S4, SS, SP, SC, M1, M2, M3, M4, MA, MB, MC, AM, AC	—	twisted wire 0.5 to 1.25 single 0.5 to 1.25	twisted wire 20 to 16 single 20 to 16	Shielded twisted-pair wires
		E (G)	M3.5	0.5 to 2	20 to 14	

<1> Wire size is determined by 75°C temperature-rated copper wire.

Note: Cable size is selected assuming external wiring of single 3-core cables at an ambient temperature of 30°C
Note: For model number 4011 and 4015, use closed-loop connectors that are recommended by JST (JST 3.5 - R5).

◆ Closed-Loop Connectors Size

Yaskawa recommends using closed-loop crimp terminals.

UL/cUL approval requires the use of closed-loop crimp terminals when wiring the main circuit terminals.

Use only the tools recommended by the terminal manufacturer for crimping.

Table 3.6 Closed Loop Connectors Sizes (JIS C 2805) (For 200 V/400 V classes)

Wire Size		Terminal Screw	Tightening Torque (N•m)	Closed Loop Connectors
mm ²	AWG			
0.5	20	M3.5 M4	0.8 to 1.0 1.2 to 1.4	R1.25-3.5 R1.25-4
0.75	18			
1.25	16			
2	14	M4	1.2 to 1.4	R2-4
		M5	2.1 to 2.5	R2-5
3.5	12	M4	1.2 to 1.4	3.5-4
		M5	2.1 to 2.5	3.5-R5
5.5	10	M4	1.2 to 1.4	R5.5-4
		M5	2.1 to 2.5	R5.5-5
8	8	M5	2.1 to 2.5	R8-5
		M6	3.6 to 5.1	R8-6
14	6	M6	3.6 to 5.1	R14-6
22	4	M8	8.2 to 10.2	R22-8
30/38	3/2	M8	8.2 to 10.2	R38-8
30/38	3/2	M10	18 to 23	R38-10
50/60	1/1/0			R60-10
80	3/0			R80-10
100	4/0			R100-10
100	4/0	M12	31.5 to 39.5	R100-12
150	300			R150-12
200	400			R200-13

Note: Determine the wire size for the main circuit so that line voltage drop is within 2% of the rated voltage. Line voltage drop is calculated as follows:
 (If there is a possibility of excessive voltage drop, use a larger wire suitable to the required length.)
 Line voltage drop (V) = $\sqrt{3}$ x wire resistance (Ω /km) x wire length (m) x current (A) x 10^{-3}

3.5 External Terminals

◆ Main Circuit Terminal Functions

Table 3.7 Main Circuit Terminal Functions

Terminal Symbol		Description
R/L1 S/L2 T/L3	Power Regenerative Unit Main Circuit Input	Main circuit AC power supply terminal for the power regenerative unit.
(+), ⊖		Connect to the Drive's DC power supply voltage input terminals. • Two terminals are provided for both (+) and ⊖.
r1/ℓ11Δ1/ℓ21 t1/ℓ31	Power Supply Voltage Detection	Detects the phase sequence and the voltage level. • Connect to the power side of the power coordinating reactor.
	Power Input for FAN and MC	Supplies power for the cooling fan and inrush prevention MC of the power regenerative unit.

◆ Control Circuit Terminal Functions

Table 3.8 Control Circuit Terminal Functions

Type	No. <1>	Signal Input	Function	Function	Signal Level
Sequence Input	S1	MANUAL RUN	Run when CLOSED, stops when OPEN		24 VDC 8 mA Photocoupler isolation
	S2	AUTO RUN	Auto run (regenerative operation) when CLOSED		
	S3	EXTERNAL FAULT INPUT	External fault when CLOSED	Multi-function Contact Inputs (H1-01 to H1-02)	
	S4	FAULT RESET INPUT	Fault reset when CLOSED		
	SC	Sequence Common			
	SS	Photocoupler internal common			
	SP	Sequence +24 V Power Supply			
Photocoupler Output	M1 - M2	CONV READY	Closed when power regenerative unit is READY	H2-01 to H2-02	48 VDC 80 mA or less
	M3 - M4	RUN	CLOSE during run		
Relay Output	MA - MC MB - MC	FAULT Output	Outputs when a fault is detected. Terminal MA-MC: Closed during fault detection Terminal MB-MC: Open during fault detection	Outputs when a fault is detected. Terminal MA-MC: Closed during fault detection Terminal MB-MC: Open during fault detection	250 VAC 1 A or less 30 VDC 1 A or less
Analog Output	AM	Input Current	5 V: 100% of rated input current	Multi-function Analog Output (H1-04)	- 10 V to + 10 VDC 2 mA or less
	AC	Analog Ground			

<1> Indicates the terminal number of the control card.

Operation

4.1 SECTION SAFETY	34
4.2 CHECKS PRIOR TO MAIN POWER APPLICATION	35
4.3 SETTING THE POWER SUPPLY VOLTAGE JUMPER	36
4.4 USING THE DIGITAL OPERATOR	37
4.5 DIGITAL OPERATOR MODES	39
4.6 POWER ON/OFF SEQUENCE	43
4.7 RUN COMMAND SELECTION	44

4.1 Section Safety

WARNING

Only turn ON the input power supply after replacing the front cover or the terminal cover. Do not remove the cover while power is on.

Failure to observe this warning can result in an electric shock.

Never operate the digital operator or other switches when your hand is wet.

Failure to observe this warning can result in an electric shock.

Never touch the terminals while current is flowing, even if the power regenerative unit stops.

Failure to observe this warning can result in an electric shock.

CAUTION

Never touch the heatsink or input reactors since their temperature may be very high.

Failure to observe this caution can result in harmful burns to the body.

All the constants of the power regenerative unit have been preset at the factory. Do not change the settings unnecessarily.

The power regenerative unit may be damaged.

4.2 Checks Prior to Main Power Application

Check the following before turning ON the power supply.

- Check that the power supply is of the correct voltage.
200 V class: 200 to 230 VAC, 50/60 Hz
400 V class: 380 to 460 VAC, 50/60 Hz
- Make sure that the power regenerative unit and the Drive are connected correctly.
- Make sure that the phase sequence of the main circuit terminals (R/L1, S/L2, T/L3) and the power supply voltage detection terminals (r1/ℓ11, s1/ℓ21, t1/ℓ31) are correct.
- Make sure that the power regenerative unit and the control device are wired correctly.
- Set the run command of the power regenerative unit and the drive to OFF.

4.3 Setting the Power Supply Voltage Jumper

Note: 400 V CLASS REGENERATIVE UNITS OF 37 kW OR HIGHER

Set the power supply voltage jumper for 400 V class power regenerative unit of 37 kW or higher. Insert the jumper into the voltage connector nearest to the actual power supply voltage.

Incorrect connector setting may negatively impact the performance of the power regenerative unit.

The jumper is factory-set to 460 V when shipped. If the power supply voltage is not 460 V, use the following procedure to change the setting.

1. Turn OFF the power supply switch and wait for at least five minutes before removing the front panel and setting the jumper.
2. Remove the front cover.
3. Insert the jumper at the position for the voltage supplied to the power regenerative unit (see [Figure 4.1](#)).
4. Replace the front cover.

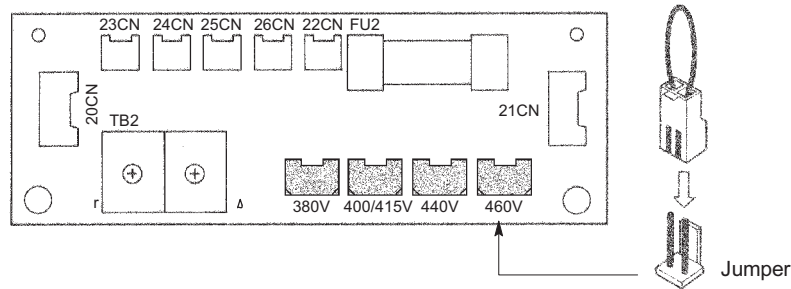

Figure 4.1 Setting the Power Supply Voltage (For 400 V Class Power Regenerative Unit between 37 kW and 75 kW)

4.4 Using the Digital Operator

This section describes the component names and functions of the Digital Operator. The component names and functions are shown in [Figure 4.2](#) and Key function are described in [Table 4.1](#).

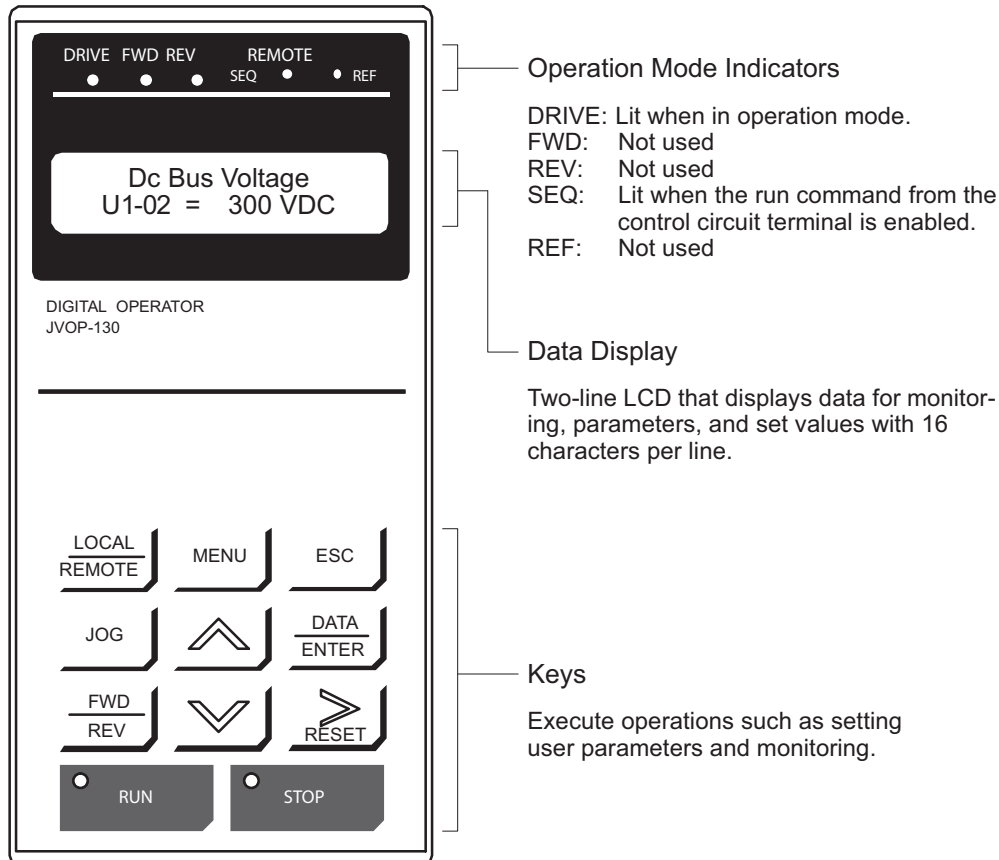









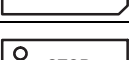
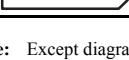

Figure 4.2 Digital Operator Component Names and Functions

4.4 Using the Digital Operator

Table 4.1 Key Function

Key	Name	Function
	LOCAL/REMOTE Key	Switches between operation (LOCAL) via the Digital Operator and control circuit terminal (REMOTE) operation. This key can be enabled or disabled by setting o2-01.
	MENU Key	Displays menus.
	ESC Key	Returns to the status before the DATA/ENTER Key was pressed.
	JOG Key	Not used.
	FWD/REV Key	Not used.
	RESET Key	Set the number of digits for parameter settings. Also acts as the reset Key when a fault has occurred.
	Increment Key	Selects menu items, groups, functions, and parameter names, and increments set values.
	Decrement Key	Selects menu items, groups, functions, and parameter names, and decrements set values.
	DATA/ENTER Key	Enters menu items, functions, parameters, and set values after they are set.
	RUN Key	Starts the RC5 operation when the RC5 is in operation with the Digital Operator.
	STOP Key	Stops RC5 operation. This Key can be enabled or disabled by setting o2-02 when operating from the control circuit terminal.

Note: Except diagrams, keys are referred to using the key names listed in the above table.

4.5 Digital Operator Modes

This section describes the RC5's monitor modes, switching between modes, and accessing/setting user parameters.

◆ Modes

The RC5's user parameters and monitoring functions have been organized in groups called modes that make it easier to read and set user parameters. The RC5 is equipped with 4 modes, as shown in [Table 4.2](#).

Table 4.2 Modes

Mode	Primary function(s)
Operation mode	The power regenerative unit can be run in this mode. Use this mode when monitoring values such as frequency references or output current, displaying fault information, or displaying the fault history.
Initialize mode	Use this mode when selecting the language displayed on the Digital Operator, selecting the access level for reading/setting user parameters, selecting the control mode, or initializing the user parameters. Factory setting: English (A1-00=0)
Programming mode	Use this mode when reading/setting the user constants required for operation. The program mode functions are subdivided into the following groups: <ul style="list-style-type: none"> • Application: Operation mode selection • Tuning: No Auto-Tuning • Option: No Option Card support • Terminal: Settings for sequential I/O and analog I/O • Protection: Settings for the motor and power regenerative unit protection function • Operator: Selects the Digital Operator's display and Key function
Modified constants mode	Use this mode to read/set user parameters that have been changed from their factory set values.

4.5 Digital Operator Modes

◆ Navigating Digital Operator Modes

Once the power regenerative unit has been put into operation mode by pressing the Menu Key, the Increment and Decrement Keys can be pressed to switch to other modes. Press the DATA/ENTER Key to read/set the user parameters in each mode.

Press the ESC Key to return to the mode display from the user parameter display.

Press the DATA/ENTER Key twice to write a parameter and then press the ESC Key to return to the mode display. This is the most Basic operation, so you should remember it.

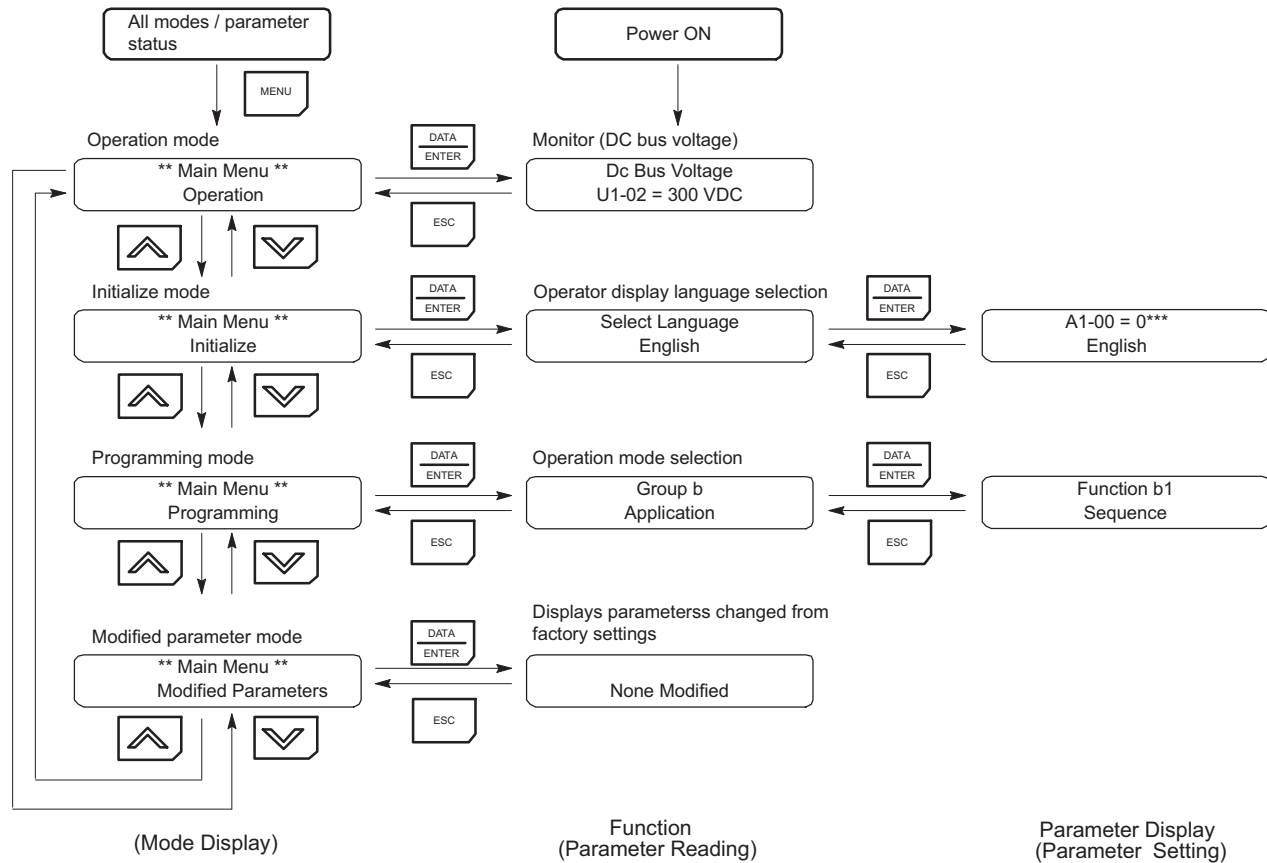



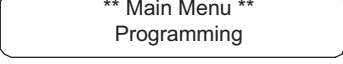

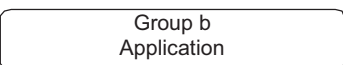

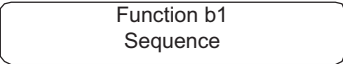

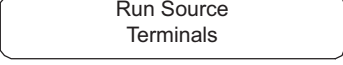

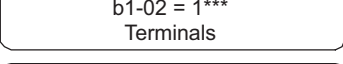

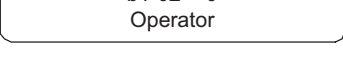

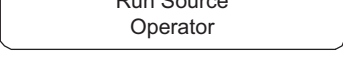

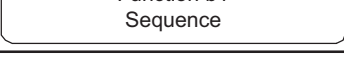

Figure 4.3 Mode Transitions

Note: When running the power regenerative unit after using the digital operator, press the MENU Key to enter the operation mode and then press the DATA/ENTER Key from the operation mode display to bring up the monitor display. Run commands can't be received from any other display. (Monitor display in the operation mode appears when the power is turned ON.)

■ **Parameter Setting Example**

The group level will be displayed when the DATA/ENTER Key is pressed at the programming mode display.

Step	Key Sequence	Digital Operator Display	Remarks
1			
2	 Press twice.		
3			
4			Changed to parameter reading (function) level.
5			
6			
7	 Press twice.		
8			Writes-in the new setting.
			After a few seconds, the operator display is as shown on the left.
9			

The parameter setting has been completed (operation mode has changed from the external terminals to the operator).

4.5 Digital Operator Modes

◆ Operation Mode

Operation mode is the mode in which the power regenerative unit can be operated. Many user parameters can't be changed when the power regenerative unit is operating.

Viewing monitor displays, fault information and fault history are possible in operation mode.

Note: When running the power regenerative unit after using digital operator, press the MENU Key to enter the operation mode and then press the DATA/ENTER Key from the operation mode display to bring up the monitor display. Run commands can't be received from any other display. (Monitor display in the operation mode appears when the power is turned ON.)

■ Operations in Operation Mode

Key operations in operation mode are shown in *Figure 4.4*.

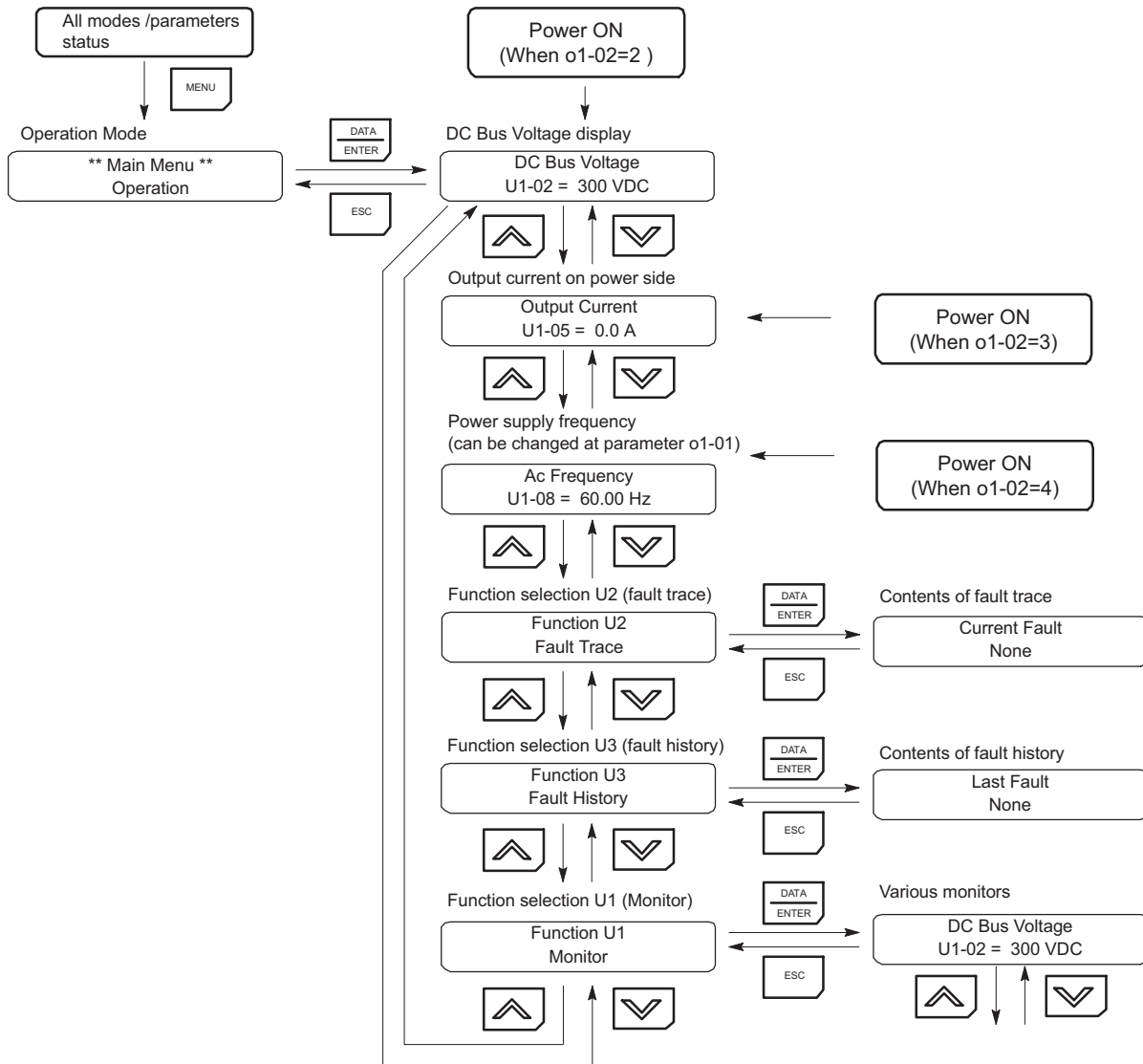

Figure 4.4 Operations in Operation Mode

4.6 Power On/Off Sequence

Refer to [Figure 4.5](#) when building a power ON/OFF sequence for the RC5.

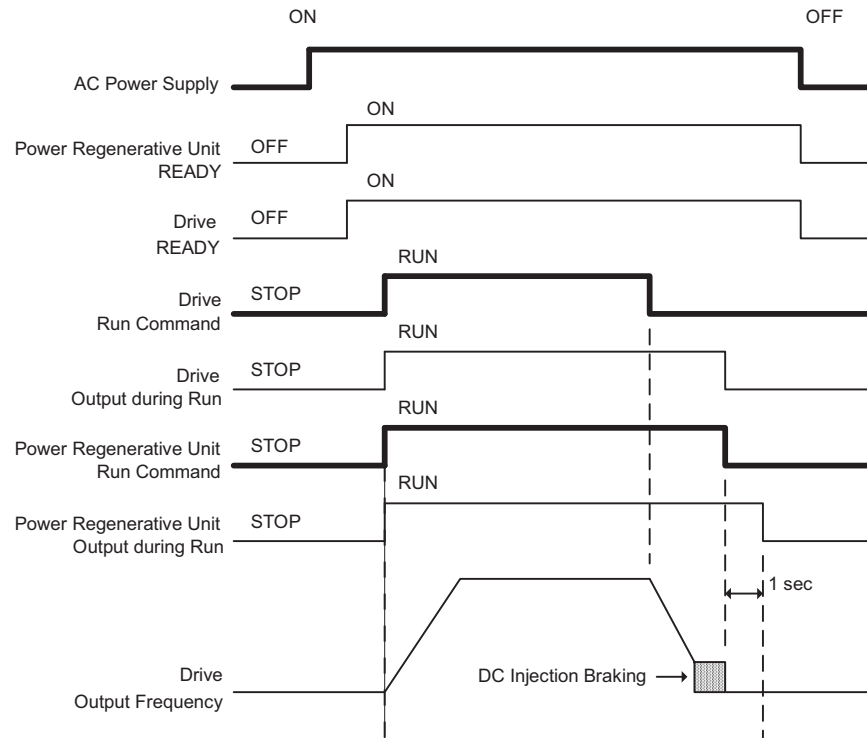

Figure 4.5 Power Supply ON/OFF Sequence

Check the following when using the power regenerative unit.

- Run commands of the drive and the power regenerative unit should be turned ON after confirming that the drive and the power regenerative unit are READY.
- Run commands of the drive and the power regenerative unit should be turned ON at the same time.
- Never turn the run command of the power regenerative unit OFF while the drive output during run is ON.
- Run output of the power regenerative unit turns OFF one second after the run command is turned OFF.
- Turn the power OFF after the run output of the power regenerative unit is OFF.

4.7 Run Command Selection

This section explains the two run command modes of the power regenerative unit. Select the mode according to the application.

◆ Auto Run

Auto run is the mode in which the power regenerative unit detects any increase/decrease of the bus voltage and performs an auto run/stop if the terminal S2-SC is “closed.”

When the DC voltage is less than the voltage set at the auto run/stop level, the RC5 will stop after the preset time value in parameter C8-20 is passed (default: 1 sec).

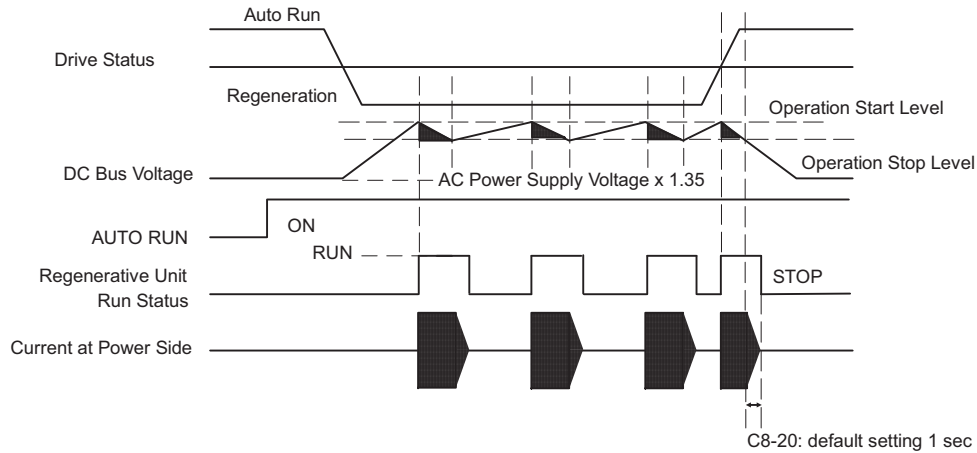

Figure 4.6 Time chart of the Auto Run Mode

◆ Manual Run

Manual run is the mode in which the RC5 starts running when the terminal S1-SC is “closed,” and stops one second after S1-SC is “open.”

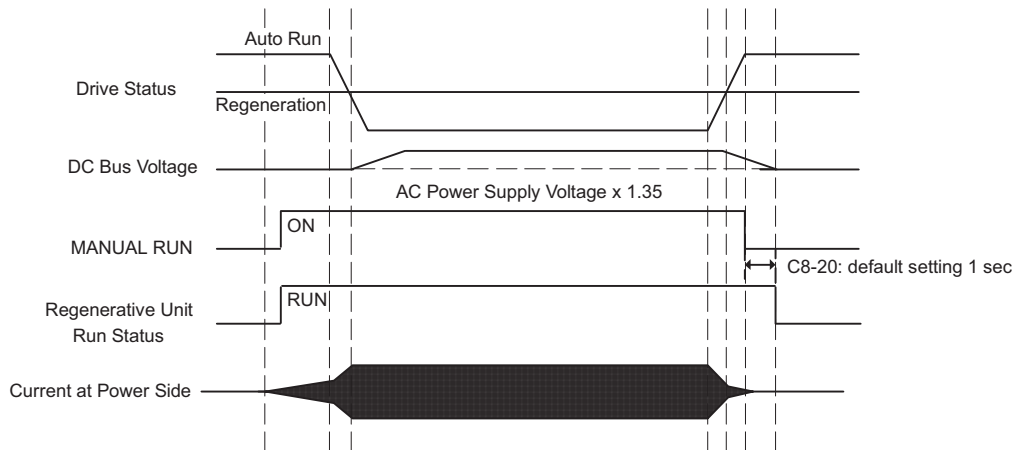

Figure 4.7 Time chart of the Manual Run mode

Build a sequence so that the run commands of the power regenerative unit and the inverter are turned ON at the same time.

5

Maintenance and Inspection

5.1 SECTION SAFETY	46
5.2 PERIODIC INSPECTION AND MAINTENANCE	47

5.1 Section Safety

WARNING

Never touch high-voltage terminals in the power regenerative unit.

Failure to observe this warning can result in an electric shock.

Perform maintenance or inspection only after verifying that the CHARGE LED goes OFF, after the main circuit power supply is turned OFF.

The capacitors are still charged and can be dangerous.

Only authorized personnel should be permitted to perform maintenance, inspections or parts replacement.

[Remove all metal objects (watches, bracelets, etc.) before operation.] (Use tools which are insulated against electric shock.) Failure to observe this warning can result in an electric shock.

Never modify the product.

Failure to observe this warning can result in an electric shock or personal injury and will invalidate the guarantee.

CAUTION

The power regenerative unit employs semi-conductor elements. Do not touch the CMOS elements.

They are easily damaged by static electricity.

Do not connect or disconnect wires or connectors while power is applied to the circuit.

Failure to observe this caution can result in personal injury.

5.2 Periodic Inspection and Maintenance

The maintenance period of the power regenerative unit is as follows.

Maintenance period: Within 18 months of shipping from the factory or within 12 months of being delivered to the final user, whichever comes first.

◆ Daily Inspection

Check the following items with the system in operation.

- There should be no abnormal heat generation.
- The ambient temperature should not be too high.
- The cooling fan on the power regenerative unit should be operating normally.

◆ Periodic Inspection

Check the following items during periodic maintenance.

Always turn OFF the power supply before beginning inspection. Confirm that the LED indicators on the front cover have all turned OFF, and then wait at least five minutes have elapsed before beginning the inspection. Be sure not to touch terminals right after the power has been turned OFF. Doing so can result in an electric shock.

Table 5.1 Periodic Inspections

Item	Inspection	Corrective Procedure
External terminals, mounting bolts, connectors, etc.	Are all screws and bolts tight?	Tighten loose screws and bolts firmly.
	Are connectors tight?	Reconnect the loose connectors.
Heatsink	Are the fins dirty?	Clean off any dirt and dust with an air gun using dry air at a pressure of 39.2×10^4 to 58.8×10^4 Pa (4 to 6 kg \cdot cm 2).
PCBs	Is there any conductive dirt or oil mist on the PCBs?	Clean off any dirt and dust with an air gun using dry air at a pressure of 39.2×10^4 to 58.8×10^4 Pa (4 to 6 kg \cdot cm 2). Replace the boards if they cannot be made clean.
Cooling fan	Is there any abnormal noise or vibration or has the total operating time exceeded 20,000 hours? <I>	Replace the cooling fan.
Power elements	Is there any conductive dirt or oil mist on the elements?	Clean off any dirt and dust with an air gun using dry air at a pressure of 39.2×10^4 to 58.8×10^4 Pa (4 to 6 kg \cdot cm 2).
Smoothing capacitor	Are there any irregularities, such as discoloration or odor?	Replace the capacitor or power regenerative unit.

<I> Unit power must be ON to perform this check.

◆ Periodic Maintenance of Parts

The power regenerative unit is configured of many parts, and these parts must be operating properly in order to make full use of its functionality.

Among the electronic components, there are some that require maintenance depending on their usage conditions. In order to keep the power regenerative unit operating normally over a long period of time, it is necessary to perform period inspections and replace parts according to their service life.

When replacing parts, be careful not to drop any, such as screws, inside the RC5. Failure to observe this caution may result in a short-circuit and a fire.

Periodic inspection standards vary depending the installation environment and usage conditions of the power regenerative unit. The power regenerative unit's maintenance periods are noted below. Keep them as reference.

Table 5.2 Part Replacement Guidelines

Part	Standard Replacement Period	Replacement Method
Smoothing capacitor	5 years	Replace with new part. (Determine need by inspection.)
Breaker relays	—	Determine need by inspection.
Fuses	10 years	Replace with new part.
Aluminum capacitors on PCBs	5 years	Replace with new board. (Determine need by inspection.)

Note: Usage conditions are as follows: • Ambient temperature: Yearly average of 30°C • Load factor: 80% max. • Operating rate: 12 hours max. per day.

5.2 Periodic Inspection and Maintenance

This page intentionally blank.

Troubleshooting

6.1 FAULT DETECTION	50
6.2 MINOR FAULT DETECTION	52
6.3 OPERATION ERRORS	53

6.1 Fault Detection

When the power regenerative unit detects a fault, the fault code is displayed on the Digital Operator and the fault contact output operates.

When a fault has occurred, refer to the following table to identify and correct the cause of the fault.

Use one of the following methods to reset the fault after restarting the power regenerative unit.

- Turn ON the fault reset signal.
- Press the RESET Key on the Digital Operator.
- Turn the main circuit power supply OFF and then ON again.

Table 6.1 Fault Displays and Processing

Fault Display	Meaning	Probable Causes	Corrective Actions
PUF IGBT, Fuse Failure	Fuse Blown The fuse in the main circuit is blown. The main transistor has damaged.	The output transistor has failed because of a short-circuit or overcurrent.	Replace the power regenerative unit after correcting the cause.
UV1 Dc Bus Undervolt	Main Circuit Undervoltage The main circuit DC voltage is below the undervoltage detection level (L2-05). 200 V class: Approx. 190 VDC 400 V class: Approx. 380 VDC	<ul style="list-style-type: none"> • An open-phase occurred with the input power supply. • A momentary power loss occurred. • The wiring terminals for the input power supply are loose. 	Reset the fault after correcting its cause.
UV2 CTR PS Undervolt	Control Power Fault The control power supply voltage dropped.	—	<ul style="list-style-type: none"> • Try turning the power supply off and on. • Replace the power regenerative unit if the fault continues to occur.
UV3 MC Answerback	Inrush Prevention Circuit Fault A fault occurred in the inrush prevention circuit.	—	<ul style="list-style-type: none"> • Try turning the power supply off and on. • Replace the power regenerative unit if the fault continues to occur.
AUv Ac Undervoltage	AC Power Undervoltage AC power undervoltage occurred during running. 200 V class: Approx. 150 VAC or less 400 V class: Approx. 300 VAC or less	<ul style="list-style-type: none"> • An open-phase occurred with the input power supply. • A momentary power loss occurred. • The wiring terminals for the input power supply are loose. 	Reset the fault after correcting its cause.
FdVe Power F Fault	Power Supply Frequency Fault AC power supply frequency has exceeded the setting value (F1-10).	<ul style="list-style-type: none"> • The power supply fluctuations occurred during running. • Power loss occurred during running. 	Reset the fault after correcting its cause.
SrC Power Supply Flt.	Power Supply Fault The phase of the input power supply has changed after turning ON the control power supply.	<ul style="list-style-type: none"> • An open-phase occurred with the input power supply. • A momentary power loss occurred. • The wiring terminals for the input power supply are loose. 	Reset the fault after correcting its cause.
OC Over Current	Overcurrent The output current of the power regenerative unit exceeded the overcurrent detection level. (200% of rated current)	<ul style="list-style-type: none"> • A short-circuit occurred at the power regenerative output. • Power supply drop • Faulty wiring 	Reset the fault after correcting its cause.
SC Short Circuit	IGBT Short-circuit The IGBT gate signal was short-circuited.	A short-circuit of the PWM signal occurred.	Replace the control card.
OV Dc Bus Overvolt	Main Circuit Overvoltage The main circuit DC voltage exceeded the overvoltage detection level. 200 V class: Approx. 400 VDC 400 V class: Approx. 800 VDC	The deceleration time is too short and the regenerative energy from the motor is too large.	<ul style="list-style-type: none"> • Increase the deceleration time. • Check the capacity of the power regenerative unit. • (Increase the capacity.)
		The power supply voltage is too high.	Decrease the voltage so it is within specifications.
OH Heatsink Overtmp	Heatsink Overheating The temperature of the power regenerative unit's cooling fins exceeded the setting in L8-02. (Stopping method can be changed by L8-03.)	The ambient temperature is too high.	Install a cooling unit.
		There is a heat source nearby.	Remove the heat source.
		The cooling fan of the power regenerative unit has stopped.	Replace the cooling fan. (Contact our sales representative.)
OH1 Heatsink Max temp	Heatsink Overheating The temperature of the power regenerative unit's cooling fins exceeded 105°C. (Stopping method: Coast to stop)	The ambient temperature is too high.	Install a cooling unit.
		There is a heat source nearby.	Remove the heat source.
		The cooling fan of the power regenerative unit has stopped.	Replace the cooling fan. (Contact our sales representative.)

Fault Display	Meaning	Probable Causes	Corrective Actions
OL Input Over Loaded	Power Regenerative Unit Input Overload Power regenerative unit input exceeded the overload capacity.	The load is too heavy.	Check the size of the load.
EF3 External Fault 3	External fault (terminal S3-SC)	An external fault was input from a multi-function input.	<ul style="list-style-type: none"> Reset external fault inputs to the multi-function inputs. Remove the cause of the external fault.
EF4 External Fault 4	External fault (terminal S4-SC)		
OPR Oper Disconnect	Operator Connection Fault The Operator was disconnected during operation started by a run command from the Operator.	—	Check the Operator connection.
ERR EEPROM R/W Err	EEPROM Write Error	—	A verification error occurred when writing EEPROM. Try turning the power supply off and on again. Try setting the constants again.
CPF00 COM-ERR (OP&CONV)	Control Circuit Error 1 (Operator Communications Error)	<ul style="list-style-type: none"> Communications with the digital operator were not established within 5 seconds after the power was turned on. MPU peripheral element check fault. 	<ul style="list-style-type: none"> Disconnect the digital operator and then connect it again. Check the wiring of the control circuit power supply. Replace the control card.
CPF01 COM-ERR (OP&CONV)	Control Circuit Error 2 (Operator Communications Error)	<ul style="list-style-type: none"> After communications were established, there was a transmission error with the digital operator for more than 2 seconds. MPU peripheral element check fault 	<ul style="list-style-type: none"> Disconnect the digital operator and then connect it again. Check the wiring of the control circuit power supply. Replace the control card.
CPF02 BB Circuit Err	Baseblock Circuit Error	The control circuit is damaged.	Replace the control card.
CPF03 EEPROM Err	EEPROM Error		
CPF04 Internal A/D Err	CPU Internal A/D Converter Error		

6.2 Minor Fault Detection

Minor faults are a type of the protection function that do not operate the fault contact output and are automatically returned to their original status once the cause of the minor fault has been removed.

The Digital Operator display blinks.

Take appropriate countermeasures according to the table below.

Table 6.2 Minor Fault Displays and Processing

Minor Fault Display	Meaning	Probable Causes	Corrective Actions
UV Dc Bus Undervolt	Main Circuit Undervoltage The main circuit DC voltage was below the undervoltage detection level (L2-05). 200 V class: Approx. 190 VDC or less 400 V class: Approx. 380 VDC or less	See causes for AUv, FdVe, SrC, and UV3 faults.	—
OV Dc Bus Overvolt	Main Circuit Overvoltage The main circuit DC voltage exceeded the overvoltage detection level. 200 V class: Approx. 400 VDC 400 V class: Approx. 800 VDC	The regenerative energy from the motor is too large.	Check the capacity of the power regenerative unit. (Increase the capacity.)
		The power supply voltage is too high.	Decrease the voltage so it is within specifications.
OH Heatsink Overtmp	Heatsink Overheating The temperature of the power regenerative unit's cooling fins exceeded the setting in L8-02. (Stopping method can be changed by L8-03.)	The ambient temperature is too high.	Install a cooling unit.
		There is a heat source nearby.	Remove the heat source.
		The cooling fan of the power regenerative unit has stopped.	Replace the cooling fan. (Contact your YASKAWA representative.)
OL Input Over Loaded	Power Regenerative Unit Input Overload Power regenerative unit input exceeded the overload capacity.	The load is too heavy.	Check the size of the load.
EF3 External Fault 3	External fault (terminal S3-SC)	An external fault was input from a multi-function input.	<ul style="list-style-type: none"> Reset external fault inputs to the multi-function inputs. Remove the cause of the external fault.
EF4 External Fault 4	External fault (terminal S4-SC)		

6.3 Operation Errors

After the parameters have been set, an operation error will occur if there is an invalid setting or a contradiction between two parameter settings.

It won't be possible to start the power regenerative unit until the parameters have been set correctly. (The minor fault output and fault contact output will not operate, either.)

When an operation error has occurred, refer to the following table to identify and correct the cause of the errors.

Table 6.3 Operation Error Displays and Incorrect Settings

Display	Meaning	Incorrect settings
OPE01 kVA Selection	Incorrect Power Regenerative Unit Capacity Setting	The power regenerative unit capacity setting does not match the Unit. (Contact your YASKAWA representative.)
OPE02 Limit	Parameter Setting Range Error	The parameter setting is outside of the valid setting range.
OPE03 Terminal	Multi-function Input Selection Error	The same setting has been selected for two or more multi-function inputs (H1-01, H1-02)

This page intentionally blank.

Specifications

- Note:**
1. Consult the factory if connecting more than one inverter to one power regenerative unit.
 2. **Heavy duty applications** require continuous energy dissipation (100% braking torque). The overload rating is 125% for 60 seconds with a duty cycle of 25%. Braking torque of 187.5% is available for 30 seconds. Please note the peak torque should be less than 250%.
 3. **Standard duty applications** require intermittent full energy dissipation. The continuous rating is 80% or less braking torque and 100% braking torque for 60 seconds with a duty cycle of 25% (60 seconds maximum on-time of every 240 seconds). The overload rating is 150% braking torque for 30 seconds. Please note the peak torque should be less than 200%.
 4. Do not use this unit with single-phase power. Use three-phase power.
 5. Imbalance rate between phases can be calculated using the following formula (Conforming to IEC1800-3). Imbalance rate between phases [%] = Three-phase average voltage divided by (Max. voltage - Min. voltage) x 67. Use a power regenerative unit with larger output capacity if the imbalance rate between phases exceeds 2%

Table 7.1 200 V Class Specifications

Model CIMR-R5U□				23P7	25P5	27P5	2011	2015	2018	2022	2030	2037
Rating	Rated Capacity	Heavy Duty (See Note 2)	HP (kW)	3 (2.2)	5 (3.7)	7.5 (5.5)	10 (7.5)	15 (11)	20 (15)	25 (18.5)	30 (22)	40 (30)
			Rated Current on Input Side (100% Cont.)	8	12	16	24	32	40	48	64	80
		Standard Duty (See Note 3)	HP (kW)	5 (3.7)	7.5 (5.5)	10 (7.5)	15 (11)	20 (15)	25 (18.5)	30 (22)	40 (30)	50 (37)
			Rated Current on Input Side (100%, 60s)	10	15	20	30	40	50	60	80	100
Rated DC Current A				13	19	26	37	51	64	77	102	126
Regenerative Torque				Heavy Duty: 100% cont., 125% for 60 s (25% ED), 187.5% for 30 s, max. torque < 250% Standard Duty: 80% cont., 100% for 60s (25% ED), 150% for 30s, max. torque < 200%								
Input Power Supply	Voltage Frequency			200 to 220 VAC 50 Hz, 200 to 230 VAC 60 Hz								
	Allowable Voltage Fluctuation			+ 10 to - 15% (Imbalance rate between phases: within 2%) (See Note 5)								
	Allowable Frequency Fluctuation			± 3 Hz (3 phase rotation)								
Control Characteristics	Control Method			120° current conduction								
	Input Power Factor			0.9 or more (Rated current)								
	Overload Capacity			Standard Duty: 150% for 30 seconds Heavy Duty: 187.5% for 30 seconds								
	Programmable Input / Output			Two Digital Inputs, Two Digital Outputs, One Analog Output.								
Operation Input				External terminals								
Status Output	Fault			1C contact output								
	PHC Output			Photocoupler output: 1 point can be selected (ready)								
	Analog Output			Analog output: 1 point can be selected (current monitor)								
Protective Function	Instantaneous Overcurrent			Standard Duty: Stops at approx. 200% of the current on power side Heavy Duty: Stops at approx. 250% of the current on power side								
	Blown Fuse			Motor stops by blown fuse.								
	Overload			Standard Duty: Stops after 30 seconds at 150% of rated current. Heavy Duty: Stops after 30 seconds at 187.5% of rated current.								
	Undervoltage (DC Voltage)			Stops at approx. 190 VDC or less.								
	Undervoltage (Power Side Voltage)			Stops at approx. 150 VAC or less.								
	Overload			Stops at approx. 400 VDC or more.								
	Fin Overheat			Protected by thermistor								
	Power Supply Open Phase (See Note 4)			Stops at power supply open phase detection.								
	Power Frequency Error			Stops by fluctuation more than ± 3 Hz of rated input frequency.								
Power Charge Indication			Indicated until main output voltage is approx. 50 V or less.									
Environmental Conditions	Location			Indoor (Protected from corrosive gases and dust)								
	Ambient Temperature			- 10°C to + 40°C (Enclosed wall-mounted type) - 10°C to + 45°C (Open chassis type)								
	Humidity			90% RH or less (non-condensing)								
	Vibration			9.8 m/s ² (1G) less than 20 Hz, up to 1.96 m/s ² (0.2G) at 20 to 50 Hz								

Table 7.2 400 V Class Specifications

Model CIMR-R5U□				43P7	45P5	47P5	4011	4015	4018	4022	4030	4037	4045	4055	4075	
Rating	Rated Capacity	Heavy Duty (See Note 2)	HP (kW)	3 (2.2)	5 (3.7)	7.5 (5.5)	10 (7.5)	15 (11)	20 (15)	25 (18.5)	30 (22)	40 (30)	50 (37)	60 (45)	75 (55)	
			Rated Current on Input Side (100% Cont.)	4	6	8	12	16	20	24	32	40	48	60	80	
		Standard Duty (See Note 2)	HP (kW)	5 (3.7)	7.5 (5.5)	10 (7.5)	15 (11)	20 (15)	25 (18.5)	30 (22)	40 (30)	50 (37)	60 (45)	75 (55)	100 (75)	
			Rated Current on Input Side (100%, 60s)	5	7.5	10	15	20	25	30	40	50	60	75	100	
	Rated DC Current A				6	9	13	19	26	32	37	51	64	77	96	128
	Regenerative Torque				Heavy Duty: 100% cont., 125% for 60 s (25% ED), 187.5% for 30 s, max. torque < 250% Standard Duty: 80% cont., 100% for 60s (25% ED), 150% for 30s, max. torque < 200%											
Input Power Supply	Voltage Frequency			380 to 460 VAC 50/60 Hz,												
	Allowable Voltage Fluctuation			+ 10 to - 15% (Imbalance rate between phases: within 2%) <1>												
	Allowable Frequency Fluctuation			± 3 Hz (3 phase rotation)												
Control Characteristics	Control Method			120° current conduction												
	Input Power Factor			0.9 or more (Rated current)												
	Overload Capacity			Standard Duty: 150% for 30 seconds Heavy Duty: 187.5% for 30 seconds												
Operation Input				External terminals												
Status Output	Fault			1C contact output												
	Running, READY Signal			Photocoupler output												
	Analog Output			Analog output: 1 point can be selected (current monitor)												
Protective Function	Instantaneous Overcurrent			Standard Duty: Stops at approx. 200% of the current on power side Heavy Duty: Stops at approx. 250% of the current on power side												
	Blown Fuse			Motor stops by blown fuse.												
	Overload			Standard Duty: Stops after 30 seconds at 150% of rated current. Heavy Duty: Stops after 30 seconds at 187.5% of rated current.												
	Undervoltage (DC Voltage)			Stops at approx. 380 VDC or less.												
	Undervoltage (Power Side Voltage)			Stops at approx. 300 VAC or less.												
	Overload			Stops at approx. 800 VDC or less.												
	Fin Overheat			Protected by thermistor												
	Power Supply Open Phase			Stops at power supply open phase detection.												
	Power Frequency Error			Stops by fluctuation more than ± 3 Hz of rated input frequency.												
Power Charge Indication			Indicated until main output voltage is approx. 50 V or less.													
Environmental Conditions	Location			Indoor (Protected from corrosive gases and dust)												
	Ambient Temperature			- 10°C to + 40°C (Closed wall-mounted) - 10°C to + 45°C (Open chassis type)												
	Humidity			90% RH or less (non-condensing)												
	Vibration			9.8 m/s ² (1G) less than 20 Hz, up to 1.96 m/s ² (0.2G) at 20 to 50 Hz												

Note: Use a power regenerative unit with larger output capacity if the imbalance rate between phases exceeds 2%.

Note: <1> Imbalance rate between phases can be calculated using the following formula (Conforming to IEC1800-3). Imbalance rate between phases [%] = Three-phase average voltage divided by (Max. voltage - Min. voltage) x 67.

This page intentionally blank.

A

Parameter List

Table A.1 shows the items that can be monitored in operation mode. The output signal levels for multi-function analog outputs shown in the table are for a gain of 100.0 and a bias of 0.00.

Table A.1 Parameters Monitored in Operation Mode

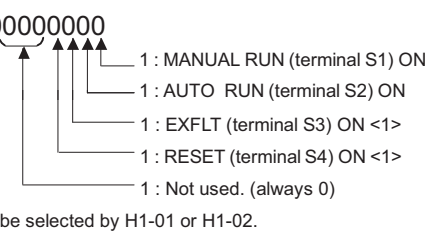
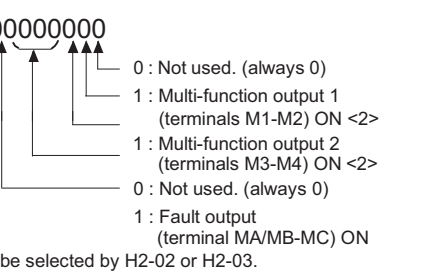
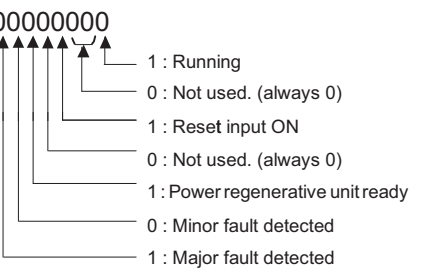
Function	Parameter No.	Parameter Name / Display	Function	Output Signal Level for Multi-function Analog Outputs	Min. Unit			
Status Monitor	U1-02	DC bus voltage	Monitors the DC voltage of the power regenerative unit's internal main circuit	200 V class: 400 V/10 V 400 V class: 800 V/10 V (0 to +10 V Output)	1 V			
		DC Bus Voltage						
	U1-04	AC power supply voltage	Monitors the AC power supply voltage.	200 V class: 200 V/5 V 400 V class: 400 V/5 V (0 to +10 V Output)	1 V			
		AC Voltage						
	U1-05	Current at power side	Monitors the AC power supply current.	Rated current /10 V (0 to +10 V Output)	1 A			
		AC Current						
	U1-07	Power at power side	Monitors the AC power supply power.	Rated power /10 V (0 to +10 V Output)	1 kW			
		AC Power						
	U1-08	AC power supply frequency	Monitors the AC power supply frequency.	60 Hz /10 V (0 to +10 V Output)	0.01 Hz			
		AC Frequency						
	U1-10	Input terminal status	Shows input ON/OFF status.	(Cannot be output)				
		Input Term Sts	Shows input ON/OFF status. U1-10 = 00000000 					
	U1-11	Output terminal status	Shows output ON/OFF status.					
		Output Term Sts	U1-11 = 00000000 					
	U1-12	Operation status	Power regenerative unit operating status.					
Int Ct1 Sts 1		U1-12 = 00000000 						
U1-13	Cumulative operation time	Monitors the power regenerative unit's elapsed operating time. Can be set with uparameter o2-07 or o2-08.						—
	Elapsed Time							
U1-14	Software No.	(Manufacturer's ID number)						—
	FLASH ID							
U1-21	Voltage deviation	Monitors the deviation between the AC power supply voltage and the main circuit DC voltage.	200 V class: 400 V/10 V 400 V class: 800 V/10 V					1 V
	V Deviation							
U1-28	Software No. (CPU)	(Manufacturer's ID number)						—
	CPU ID							

Function	Parameter No.	Parameter Name / Display	Function	Output Signal Level for Multi-function Analog Outputs	Min. Unit
Fault Trace	U2-01	Current fault	Information on the current fault	(Cannot be output)	—
		Current Fault			
	U2-02	Last fault	Information on the last fault		—
		Last Fault			
	U2-04	DC bus voltage at fault	Main circuit DC voltage value when the “last fault” occurred.		1 V
		DC Bus Voltage			
	U2-06	Power supply voltage at fault	AC power supply voltage value when the “last fault” occurred.		1 V
		AC Voltage			
	U2-07	Power side current at fault	Current value at AC power side when the “last fault” occurred.		1 A
		AC Current			
	U2-08	Power at fault	Power at AC power side when the “last fault” occurred.		1 kW
		AC Power			
	U2-10	Power side frequency at fault	Frequency at AC power side when the “last fault” occurred.		0.01 Hz
		AC Frequency			
	U2-11	Input terminal status at fault	Input terminal status when the “last fault” occurred. (Same format as U1-10.)		—
Input Term Sts					
U2-12	Output terminal status at fault	Output terminal status when the “last fault” occurred. (Same format as U1-11.)	—		
	Output Term Sts				
U2-13	Operation status at fault	Operating status when the “last fault” occurred. (Same format as U1-12.)	—		
	Regen Unit Sts				
U2-14	Cumulative operation time at fault	Elapsed operating or power-on time when the “last fault” occurred.	1 H		
	Elapsed Time				
U2-20	Voltage deviation input at fault	Voltage deviation when the “last fault” occurred.	1 V		
	V Deviation				
Fault History	U3-01	Most recent fault	Information on the last fault.	(Cannot be output)	—
		Last Fault			
	U3-02	Second most recent fault	Information on the 2nd to last fault.		—
		Fault Message 2			
	U3-03	Third most recent fault	Information on the 3rd to last fault.		—
		Fault Message 3			
	U3-04	Fourth/oldest fault	Information on the 4th to last fault.		—
		Fault Message 4			
	U3-05	Cumulative operation time at fault	Elapsed running or power-on time when the last fault occurred.		1 H
		Elapsed Time 1			
	U3-06	Accumulated time of second fault	Elapsed running or power-on time when the 2nd to last fault occurred.		1 H
		Elapsed Time 2			
	U3-07	Accumulated time of third fault	Elapsed running or power-on time when the 3rd to last fault occurred.		1 H
		Elapsed Time 3			
	U3-08	Accumulated time of fourth/oldest fault	Elapsed running or power-on time when the 4th to last fault occurred.		1 H
		Elapsed Time 4			

Table A.2 Parameter List

Parameter No.	Parameter Name	Setting Range	Factory Setting	Change during Operation	Access Level	Description
	Display					
A1-00	Language selection for operator display	0, 1	0	O	A	Language selection for the Digital Operator. This parameter is not reset to the factory setting by A1-03. 0: English 1: Japanese
	[Select Language]					
A1-01	Parameter access level	0 to 9999	4	O	A	Selects which parameters are accessible via the Digital Operator. 0: Operation only 4: Advanced Level
	[Access Level]					
A1-03	Initialize	0000 to 9999	0000	x	A	Used to return all parameters to their factory or user default settings. (Initializes and then returns A1-03 to zero.) 2220: 2-Wire Initialization
	[Init Parameters]					
A1-04	Password 1 (Input)	0000 to 9999	0	x	A	When the value set into A1-04 does NOT match the value set into A1-05, parameters A1-01 thru A1-03 cannot be changed. All other parameters as determined by A1-01 can be changed. Parameter A1-05 can be accessed by pressing the MENU key while holding the RESET key.
	[Enter Password]					
b1-02	Operation method selection	0, 1	1	x	A	Selects the run command input source. 0: Operator- RUN and STOP keys on Digital Operator. 1: Terminals - Contact closure on terminals S1 or S2.
	[Run Source]					
b1-06	Read sequence input twice	0, 1	1	x	A	Sets the scan rate of terminals S1 to S4 0: 500 ms - 2 scans (for quick response) 1: 5 ms - 2 scans (for noisy environments)
	[Cntl Input Scans]					
C8-17	Automatic operation stop current	10 to 100%	50	x	A	—
	[Autorun Iout]					
C8-18	Bias voltage at operation start	0.0 to 50.0 V	2.0	x	A	For 400 V class power regenerative units, double the initial setting and setting range.
	[V Bias of Run]					
C8-19	Hysteresis voltage width at operation start/stop	0.5 to 50.0 V	3.0	x	A	For 400 V class power regenerative units, double the initial setting and setting range.
	[V Width of Stop]					
C8-20	Min. operating time	0.0 to 600.0 sec	1.0	x	A	—
	[Minimum Run Time]					
F1-10	Excessive frequency deviation detection level	1.0 to 10.0 Hz	3.0	x	A	Configures the frequency deviation fault (DEV) detection. DEV fault will occur if the frequency deviation is greater than the F1-10 setting for a time longer than F1-11. F1-10 is set as a percentage of the maximum output frequency (E1-04). Frequency deviation is the difference between actual input supply frequency and the frequency reference command.
	[FDEV DetectLevel]					
F1-11	Excessive frequency deviation detection delay time	0.0 to 255.0 sec	70.0	x	A	
	[FDEV Detect Time]					
H1-01	Multi-function input (terminal S3)	0 to 2F	24	O	A	Selects the function of terminal S3. 24: External fault, Normally Open, Always Detected, Coast To Stop. Refer to Table A.3 .
	[Terminal S3 Sel]					
H1-02	Multi-function input (terminal S4)	0 to 2F	14	O	A	Selects the function of terminal S4. 14: Fault reset Closed = Resets the Drive after the fault and the run command have been removed. Refer to Table A.3 .
	[Terminal S4 Sel]					
H2-02	Multi-function output (terminal M1-M2)	0 to 20	6	O	A	Selects the function of terminals M1 to M2. 6: Drive ready Closed - When the Drive is powered up, not in a fault state and in the DRIVE mode. Refer to Table A.4 .
	[Terminal M1 Sel]					
H2-03	Multi-function output (terminal M3-M4)	0 to 20	0	O	A	Selects the function of terminals M2 - M4. 0: During Run 1 Closed - When a run command is input or the Drive is outputting voltage. Refer to Table A.4 .
	[Terminal M3 Sel]					

Parameter No.	Parameter Name	Setting Range	Factory Setting	Change during Operation	Access Level	Description
	Display					
H4-01	Multi-function AO (terminal AM-AC)	0 to 21	5	O	A	Selects which monitor will be output on terminals AM and AC. 0: Not used 2: DC bus voltage (U1-02) 4: AC power supply voltage (U1-04) 5: Current at power side (U1-05) 7: Power at power side (U1-07) 8: AC power supply frequency (U1-08) 21: Voltage deviation (U1-21) Refer to Table A.5 .
	[Terminal AM Sel]					
H4-02	Gain (terminal AM-AC)	0.00 to 2.50	0.50	O	A	Sets terminal AM output level when selected monitor is at 100%.
	[Terminal AM Gain]					
H4-03	Bias (terminal AM-AC)	-110.0 to +110.0%	0.0	O	A	Sets terminal AM output level when selected monitor is at 0%.
	[Terminal AM Bias]					
H4-07	Analog output signal polarity selection	0, 1	1	O	A	Selects the signal level of terminal AM. 0: 0 to 10 Vdc 1: -10 to +10 Vdc
	[AM Level Select]					
L2-01	Momentary power loss detection	0 to 2	0	x	A	Enables and disables the momentary power loss function. 0: Disabled - Unit trips on (UV1) fault when power is lost. 1: Power Loss Ride Thru Time - Unit will restart if power returns within the time set in L2-02.* 2: CPU Power Active - Unit will restart if power returns prior to control power supply shut down.* * In order for a restart to occur, the run command must be maintained throughout the ride thru period.
	[PwrL Selection]					
L2-02	Momentary power loss ride-thru time	0.0 to 2.0	2.0	x	A	Sets the power loss ride-thru time. This value is dependent on the capacity of the Unit. Only effective when L2-01 = 1.
	[PwrL Ridethru t]					
L2-05	Undervoltage detection level	150 to 210 V	190	x	A	Sets the Unit's DC Bus undervoltage trip level. If this is set lower than the factory setting, additional AC input reactance or DC bus reactance may be necessary. Consult the factory before changing this parameter setting.
	[PUV Det Level]					
L5-01	Number of auto restart attempts	0 to 10	0	x	A	Sets the counter for the number of times the Unit will perform an automatic restart. Auto restart will check to see if the fault has cleared every 5 ms. When no fault is present, the Unit will attempt an auto restart. If the Unit faults after an auto restart attempt, the counter is incremented. When the Unit operates without fault for 10 minutes, the counter will reset to the value set in L5-01.
	[Num of Restarts]					
L5-02	Auto restart operation selection	0, 1	0	x	A	Determines if the fault contact activates during an automatic restart attempt. 0: No Fault Relay - fault contact will not activate during an automatic restart attempt. 1: Fault Relay Active - fault contact will activate during an automatic restart attempt.
	[Restart Sel]					
L8-02	Overheat pre-alarm level	50 to 110 deg	95	x	A	When the cooling fin temperature exceeds the value set in this parameter, an overheat alarm (OH) will occur.
	[OH Pre-Alarm Lvl]					
L8-03	Operation selection after overheat pre-alarm	1, 3	3	x	A	Selects the Unit operation upon an OH pre-alarm detection. 1: Coast to Stop 3: Alarm Only
	[OH Pre-Alarm Sel]					
L8-07	Power supply open-phase protection selection	0, 1	0	x	A	Selects the detection of output current open-phase. When applied motor capacity is too small for Unit capacity, output phase loss may be detected inadvertently. In this case, set to 0. 0: Disabled 1: Enabled
	[Ph Loss In Sel]					
o1-01	Monitor selection	4 to 8	8	O	A	Selects which monitor will be displayed in the operation menu upon power-up when o1-02 = 4. 4: Power supply voltage (U1-04) 7: Power at power side (U1-07) 8: Power supply frequency (U1-08)
	[User Monitor Sel]					

Parameter No.	Parameter Name	Setting Range	Factory Setting	Change during Operation	Access Level	Description
	Display					
o1-02	Monitor selection after power up	2 to 4	2	O	A	Selects which monitor will be displayed upon power-up. 2: DC Bus Voltage (U1-02) 3: Output Current at the power side (U1-05) 4: Monitor set in o1-01
	[Power-On Monitor]					
o2-01	LOCAL/REMOTE key enable/disable	0, 1	1	x	A	Determines if the Digital Operator Local / Remote key is functional. 0: Disabled 1: Enabled
	[Local/Remote Key]					
o2-02	STOP key during remote operation	0, 1	0	x	A	Determines if the STOP key on the Digital Operator will stop the Unit when the Unit is operating from external terminals. 0: Enabled during run command from the digital operator 1: Enabled
	[Oper STOP Key]					
o2-04	kVA selection	00 to FF	*	x	A	Sets the kVA of the Unit. Enter the number based on the Unit model number. Use the last four digits of the model number. This parameter only needs to be set when installing a new control board. Do not change for any other reason.
	[Regen Unit Model]					
o2-06	Operation selection when digital operator is disconnected	0, 1	0	x	A	Determines if the Unit will stop when the Digital Operator is removed when in LOCAL mode or b1-02 = 0. 0: Disabled - the Unit will not stop when the Digital Operator is removed. 1: Enables - The Unit will fault (OPR) and coast to stop when the Digital Operator is removed.
	[Oper Detection]					
o2-07	Cumulative operation time setting	0 to 65535H	—	x	A	Sets the initial value of the elapsed operation timer U1-13.
	[Elapsed Time Set]					
o2-08	Cumulative operation time selection	0, 1	0	x	A	Sets how time is accumulated for the elapsed operation timer U1-13. 0: Power-On Time - Time accumulates when the Unit is powered. 1: Running Time - time accumulates only when the Unit is running.
	[Elapsed Time Run]					

Table A.3 Multi-function Input Functions

Setting Value	Function (H1-01, 02)	Remarks
8	External baseblock (NO contact) [Ext BaseBlk N.O.]	
9	External baseblock (NC contact) [Ext BaseBlk N.C.]	
F	Not used [Term Not Used]	
14	Fault reset [Fault Reset]	
24-2F	External fault [External Fault]	24: External Fault, Normally Open, Always Detected, Coast To Stop 25: External Fault, Normally Closed, Always Detected, Coast To Stop 26: External Fault, Normally Open, During Run, Coast To Stop 27: External Fault, Normally Closed, During Run, Coast To Stop 28: External Fault, Normally Open, Always Detected, Fast Stop 29: External Fault, Normally Closed, Always Detected, Fast Stop 2A: External Fault, Normally Open, During Run, Fast Stop 2B: External Fault, Normally Closed, During Run, Fast Stop 2C: External Fault, Normally Open, Always Detected, Alarm Only 2D: External Fault, Normally Closed, Always Detected, Alarm Only 2E: External Fault, Normally Open, During Run, Alarm Only 2F: External Fault, Normally Closed, During Run, Alarm Only

Table A.4 Multi-function Output Functions

Setting value	Function (H2-02, 03)	Remarks
0	During run [During RUN 1]	Closed = When a run command is input or the Unit is outputting voltage.
6	Regenerative unit ready [Regen Unit Ready]	Closed = When the Unit is powered up, not in a fault state, and in the DRIVE mode.
7	During DC bus undervoltage (UV) detection [DC Bus Undervolt]	Closed = When the DC bus voltage falls below the UV trip level set in L2-05.
8	During baseblock [BaseBlk 1]	Closed = When the Unit is not outputting voltage.
A	During MCON [Mc On]	Closed = When the pre-charge contactor contact is energized.
E	Fault [Fault]	Closed = When the Unit experiences a major fault.
F	Not used [Not Used]	
10	Alarm [Minor Fault]	Closed = When the Unit experiences an alarm.
11	Fault reset command active [Reset Cmd Active]	Closed = When the Unit receives a reset command from a digital input terminal or serial communication.
1E	Restart enabled [Restart Enabled]	Closed = When the Unit is performing an automatic restart attempt. Automatic restart is configured by parameter L5-01.
1F	Overload (OL1) pre-alarm [Overload (OL1)]	Closed = When OL1 is 80% of its trip point or greater.
20	Overheat pre-alarm [OH Prealarm]	Closed = When the Unit's heatsink temperature exceeds the setting of parameter L8-02.

Table A.5 Multi-function Analog Output Functions

Setting value	Function (H4-01)	Output signal level	Remarks
0	Not used [Not Used]		
2	DC bus voltage [DC Bus Voltage]	200 V class: 400 V/10 V 400 V class: 800 V/10 V	100% = 400 / 800 Vdc depending on the Unit voltage rating.
4	Power supply voltage [AC Voltage]	200 V class: 200 V/5 V 400 V class: 400 V/5 V (0 to +10 V output)	100% = 400 / 800 Vdc depending on the Unit voltage rating.
5	Current at power side [AC Current]	Rated current /10 V	100% = Unit current at the power side.
7	Power at power side [AC Power]	Rated power /10 V	100% = Unit power at the power side.
8	Power supply frequency [AC Frequency]	60 Hz/10 V	100% = Unit power supply frequency.
21	Voltage deviation input [V Deviation]	200 V class: 400 V/10 V 400 V class: 800 V/10 V	100% = 400 / 800 Vdc depending on the Unit voltage rating.

Revision History

Document revision dates and revision numbers are provided on the bottom of the back cover.



MANUAL NO. TOEP C710656 01A

Published in Japan February 2010 08-4 

└─ Revision number

└─ Date of original publication

└─ Date of publication

Date of Publication	Rev. No.	Section	Revised Content
August 2011		Front cover, back cover	Revision: Format
		Preface	Addition: CSA Standards Compliance in Conditions of Acceptability
			Revision: Note on Short Circuit Current Rating (SCCR) in Notes for Safe Operation
		Chapter 2	Addition: Note on UL standard in Checking Installation Site
Chapter 3	Addition: Note on UL standard in Closed-Loop Connectors Size Revision: • Note on Short Circuit Current Rating (SCCR) in Section Safety • Closed Loop Connectors Sizes Table		
September 2010		Preface	Addition: Note on Short Circuit Current Rating (SCCR) in Notes for Safe Operation
		Chapter 3	Addition: Note on Short Circuit Current Rating (SCCR) in Section Safety
		Back cover	Revision: Address
February 2010		Back cover	Revision: Address
April 2008	–	–	First edition

YASKAWA - RC5

Power Regenerative Unit

Instruction Manual

YASKAWA AMERICA, INC.

2121 Norman Drive South, Waukegan, IL 60085, U.S.A.
Phone: (800) YASKAWA (927-5292) or 1-847-887-7000 Fax: 1-847-887-7310
<http://www.yaskawa.com>

DRIVE CENTER (INVERTER PLANT)

2-13-1, Nishimiyaichi, Yukuhashi, Fukuoka, 824-8511, Japan
Phone: 81-930-25-3844 Fax: 81-930-25-4369
<http://www.yaskawa.co.jp>

YASKAWA ELECTRIC CORPORATION

New Pier Takeshiba South Tower, 1-16-1, Kaigan, Minatoku, Tokyo, 105-6891, Japan
Phone: 81-3-5402-4502 Fax: 81-3-5402-4580
<http://www.yaskawa.co.jp>

YASKAWA ELÉTRICO DO BRASIL LTDA.

Avenda Fagundes Filho, 620 Bairro Saude, São Paulo, SP04304-000, Brasil
Phone: 55-11-3585-1100 Fax: 55-11-5581-8795
<http://www.yaskawa.com.br>

YASKAWA EUROPE GmbH

Hauptstrasse 185, 65760 Eschborn, Germany
Phone: 49-6196-569-300 Fax: 49-6196-569-398
<http://www.yaskawa.eu.com>

YASKAWA ELECTRIC UK LTD.

1 Hunt Hill Orchardton Woods, Cumbernauld, G68 9LF, United Kingdom
Phone: 44-1236-735000 Fax: 44-1236-458182
<http://www.yaskawa.co.uk>

YASKAWA ELECTRIC KOREA CORPORATION

7F, Doore Bldg. 24, Yeoido-dong, Yeoungdungpo-gu, Seoul, 150-877, Korea
Phone: 82-2-784-7844 Fax: 82-2-784-8495
<http://www.yaskawa.co.kr>

YASKAWA ELECTRIC (SINGAPORE) PTE. LTD.

151 Lorong Chuan, #04-01, New Tech Park, 556741, Singapore
Phone: 65-6282-3003 Fax: 65-6289-3003
<http://www.yaskawa.com.sg>

YASKAWA ELECTRIC (SHANGHAI) CO., LTD.

No. 18 Xizang Zhong Road, 17F, Harbour Ring Plaza, Shanghai, 200001, China
Phone: 86-21-5385-2200 Fax: 86-21-5385-3299
<http://www.yaskawa.com.cn>

YASKAWA ELECTRIC (SHANGHAI) CO., LTD. BEIJING OFFICE

Room 1011, Tower W3 Oriental Plaza, No. 1 East Chang An Ave.,
Dong Cheng District, Beijing, 100738, China
Phone: 86-10-8518-4086 Fax: 86-10-8518-4082

YASKAWA ELECTRIC TAIWAN CORPORATION

9F, 16, Nanking E. Rd., Sec. 3, Taipei, 104, Taiwan
Phone: 886-2-2502-5003 Fax: 886-2-2505-1280



YASKAWA ELECTRIC CORPORATION

In the event that the end user of this product is to be the military and said product is to be employed in any weapons systems or the manufacture thereof, the export will fall under the relevant regulations as stipulated in the Foreign Exchange and Foreign Trade Regulations. Therefore, be sure to follow all procedures and submit all relevant documentation according to any and all rules, regulations and laws that may apply.

Specifications are subject to change without notice for ongoing product modifications and improvements.

© 2008-2011 YASKAWA ELECTRIC CORPORATION. All rights reserved.

MANUAL NO. TOEP C710656 01C

Published in Japan August 2011 08-4 
10-10-7_YAI